



**Technical Data / Fiche Technique / Technische Daten / Datos Técnicos**

Document Holders ■ Porte Documents ■ Dokumentenbehälter ■ Portadocumentos

**1006 SERIES / SÉRIE "1006" / 1006ER-REIHE / SERIE 1006**



1006



1006-CORE

**Features/Caractéristiques/Merkmale/Características**

New improved design - 05/2016 • Designed to store documents next to machinery (Maintenance checks, manuals, etc) • Fully recyclable, chemical resistant, UV-stabilised HDPE • Ideal for commercial vehicles, containers, forklifts, hire equipment, agricultural applications etc. • Fits A4 folders & US letter size • Suitable for indoor/outdoor use • Padlock facility (padlock not included) • Lightweight • Lid opens 180° • Smooth finish for label placement • Available in black and red as standard, other colours available on request (Min order 20 units).

Nouveau modèle - 05/2016 • Pour le stockage de documents à proximité de machines (mode d'emploi, manuel de maintenance ou procédure de sécurité) • PEHD entièrement recyclable, résistant à la plupart des produits chimiques et aux UV • Convient aux documents format A4 et US letter • Idéal pour véhicules industriels, contenaires, chariots élévateurs, équipement sécurité incendie, engins agricoles, etc. • Convient à une utilisation interne et externe • Cadenassable (cadenas non inclus) • Légères • Couvercle s'ouvrant à 180° • Emplacement prévu pour étiquette (surface lisse) • Disponible en noir et en rouge, autres couleurs disponibles sur demande (Minimum de commande de 20 pièces).

Neues, verbessertes Design - 05/2016 • als Behälter für maschinenrelevante Daten (Wartung, Bedienanleitungen, etc.) entwickelt • vollständig recycelbares, chemikalienbeständiges, UV-stabiles HDPE • für Innen-/Ausseneinsatz • ideal für Nutzfahrzeuge, Container, Gabelstapler, Mietgeräte, den landwirtschaftlichen Bereich, etc • für A4- sowie US-Letter-Format geeignet • Verschlusseinheit (ohne Vorhängeschloß) • leicht • Deckel öffnet 180° • glatte Oberfläche im Aufkleberbereich • erhältlich in Schwarz und Rot, andere Farben auf Wunsch (Mindestabnahme 20 Einheiten).

Nuevo diseño mejorado - 05/2016 • Diseñado para guardar los documentos cerca de la maquinaria (manual de mantenimiento, instrucciones, etc.) • 100% reciclable, resistente a la mayoría de los químicos, PE-HD estabilizado a los rayos UV • Apto para carpetas A4 y formato EE UU • Idóneo par vehículos comerciales, contenedores, carretillas elevadores, equipos de alquiler, aplicaciones agrícolas etcetera • Apto para el uso interior/externo • Se puede cerrar con candado (candado no suministrado) • Ligero • La tapa se abre 180° • Acabado liso para fácil colocación de etiquetas • Disponible en negro y rojo como estándar, otros colores disponibles (Cantidad mínima de pedido 20 piezas).

	EAN-13	mm	mm	mm	mm	mm	mm		Documents Dokumente Documentos	kg
1006	5055644202537	320	335	270	355	65	100		A4	1
1006-CORE	5055644205040									

\*Red / Rouge / Rot / Rojo



Jonesco (Preston) Ltd.  
Pittman Way  
Fulwood  
Preston PR2 9ZD  
England  
Tel: +44 (0) 1772 704488  
Fax: +44 (0) 1772 702209  
sales@jonesco-plastics.com





**Technical Data / Fiche Technique / Technische Daten / Datos Técnicos**

Document Holders ■ Porte Documents ■ Dokumentenbehälter ■ Portadocumentos

**1006 SERIES / SÉRIE "1006" / 1006ER-REIHE / SERIE 1006**

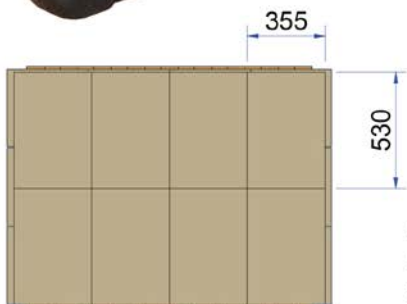
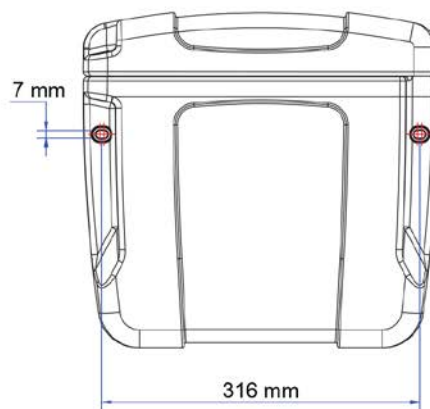
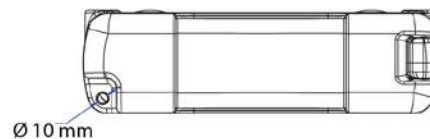
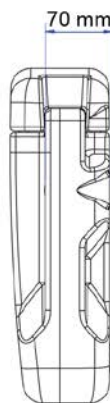

220 units per pallet  
 220 pièces par palette  
 220 Teile pro Palette  
 220 piezas por pallet

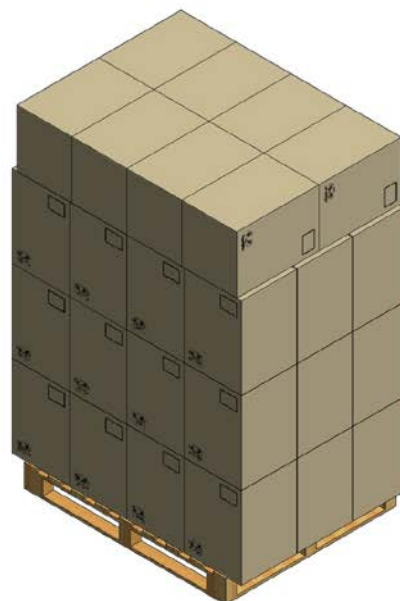
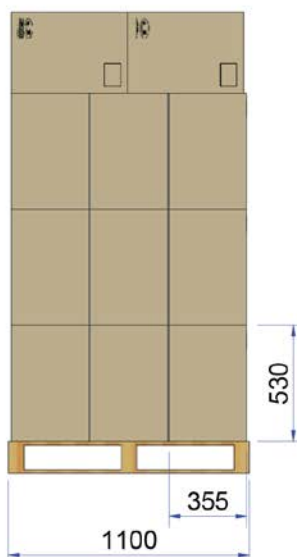
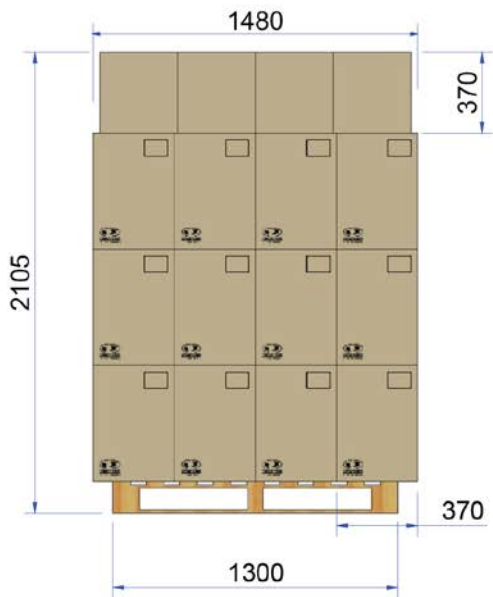

**Jonesco (Preston) Ltd.**  
 Pittman Way  
 Fulwood  
 Preston PR2 9ZD  
 England  
 Tel: +44 (0) 1772 704488  
 Fax: +44 (0) 1772 702209  
 sales@jonesco-plastics.com

