

Defibtech DDU-100 Semi-Automatic External Defibrillator



User Manual

AHA/ERC 2010

**ELECTRONIC
DISTRIBUTION**
DAC-510E-EN-BF

1



2

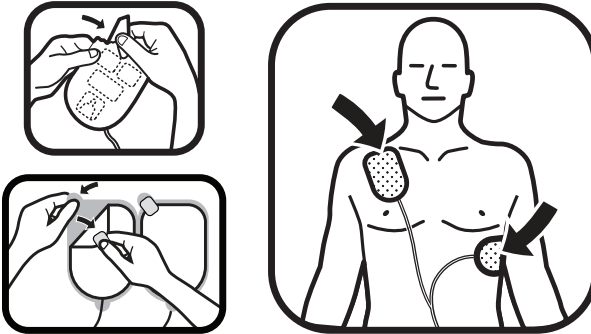

3



Notices

Defibtech shall not be liable for errors contained herein or for incidental or consequential damages in connection with the furnishing, performance, or use of this material.

Information in this document is subject to change without notice. Names and data used in the examples are fictitious unless otherwise noted.

Limited Warranty

The “Limited Warranty” shipped with Defibtech AED products serves as the sole and exclusive warranty provided by Defibtech, LLC with respect to the products contained herein.

Copyright

Copyright © 2013 Defibtech, LLC.

All rights reserved. Copyright questions should be directed to Defibtech. For contact information, refer to the “Contacts” section of this manual.



CAUTION: Federal law (USA) restricts this device to sale by or on the order of a physician

Contents

1	Introduction to the DDU-100 Series AED	1
1.1	Overview	1
1.2	The Defibtech DDU-100 AED.....	2
1.3	Indications.....	4
1.4	Contraindications	4
1.5	Operator Training Requirements	4
2	Dangers, Warnings and Cautions.....	5
2.1	Shock, Fire Hazard, Explosion	5
2.1.1	Electricity.....	5
2.1.2	Battery Pack.....	5
2.1.3	Usage Environment.....	6
2.1.4	Defibrillation/Shock Delivery	6
2.1.5	Maintenance	7
2.2	Improper Device Performance.....	7
2.2.1	Usage Environment.....	7
2.2.2	Pads	8
2.2.3	Patient Analysis.....	8
2.2.4	Shock Delivery	9
2.2.5	Maintenance	9
2.3	General.....	10
3	Setting up the DDU-100 AED.....	11
3.1	Overview	11
3.2	Installing the Data Card	12
3.3	Installing the Active Status Indicator 9V Battery	12
3.4	Installing and Removing the Battery Pack	13
3.5	Connecting the Pads	14
3.6	Performing Manually Initiated Self-Tests	15
3.7	Storing the DDU-100 AED	15
4	Using the DDU-100 AED	17
4.1	Overview	17
4.2	Checking DDU-100 AED Status	18
4.3	Turning on the DDU-100 AED.....	18

4.4	Preparation	19
4.4.1	<i>Call for Help</i>	19
4.4.2	<i>Preparing the Patient</i>	19
4.4.3	<i>Opening the Pad Package</i>	19
4.4.4	<i>Connecting Defibrillation Pads to the DDU-100 AED</i>	19
4.4.5	<i>Applying Pads to the Patient</i>	20
4.4.6	<i>Follow DDU-100 AED Prompts</i>	21
4.5	Heart Rhythm Analysis	22
4.6	Delivering the Shock	23
4.7	No Shock Required	25
4.8	Post-Shock CPR	26
4.9	Post Use Procedures	27
4.10	Operational Environment	27
5	Maintaining and Troubleshooting the DDU-100 AED	29
5.1	Self-Tests	29
5.2	Routine Maintenance	30
5.2.1	<i>Checking Active Status Indicator</i>	30
5.2.2	<i>Checking the Condition of the Unit and Accessories</i>	31
5.2.3	<i>Running a Manually Initiated Self-Test</i>	32
5.2.4	<i>Replacing Pads</i>	32
5.2.5	<i>Checking Pad and Battery Pack Expiration Dates</i>	33
5.2.6	<i>Checking the DDC If One Was Installed</i>	33
5.3	Replacing the Lithium 9V ASI Battery	34
5.4	Cleaning	35
5.5	Storage	35
5.6	Operator's Checklist	36
5.7	Troubleshooting	37
5.8	Repair	39
6	DDU-100 AED Accessories	41
6.1	Defibrillation/Monitoring Pads	41
6.2	Battery Packs	41
6.2.1	<i>Battery Pack Active Status Indicator</i>	42
6.2.2	<i>Active Status Indicator Battery</i>	42
6.3	Data Cards	42
6.4	Recycling Information	43
6.4.1	<i>Recycling Assistance</i>	43
6.4.2	<i>Preparation</i>	43
6.4.3	<i>Packaging</i>	43
6.4.4	<i>Notice to European Union Customers</i>	44

7	Event Viewing	45
7.1	Defibtech Data Cards	45
7.2	Downloading the Internal Data Log.....	46
8	Technical Specifications	47
8.1	Defibtech DDU-100 AED	47
8.1.1	Physical.....	47
8.1.2	Environmental.....	47
8.1.3	Defibrillator	48
8.1.4	Waveform Specifications	48
8.1.5	Patient Analysis System.....	49
8.1.5.1	Shockable Rhythm Criteria	50
8.1.5.2	Patient Analysis System Performance.....	51
8.1.6	Clinical Summary	51
8.1.6.1	Background.....	51
8.1.6.2	Methods.....	52
8.1.6.3	Results	52
8.1.6.4	Conclusion	52
8.1.7	Guidance and Manufacturer's Declaration – Electromagnetic Emissions and Immunity.....	53
8.2	Battery Packs	56
8.2.1	High-Capacity Lithium Battery Pack	56
8.2.2	Standard Lithium Battery Pack	56
8.3	Self-Adhesive Defibrillation/Monitoring Pads	57
8.4	Defibtech Data Cards (DDCs).....	57
8.5	DefibView.....	58
9	Glossary of Symbols	59
10	Contacts	63
11	Warranty Information.....	65

1 Introduction to the DDU-100 Series AED

This User Manual provides information to guide trained operators in the use and maintenance of the Defibtech DDU-100 series Semi-Automatic External Defibrillator (“AED”) and its accessories. This chapter includes an overview of the AED, a discussion of when it should and should not be used, and information on required operator training.

1.1 Overview

The *DDU-100* AED is a Semi-Automatic External Defibrillator (“AED”) that is designed to be easy to use, portable and battery powered. It has only two user controls: the ON/OFF and SHOCK buttons. Voice prompts and visual indicators provide a simple interface for the operator. The *DDU-100* AED is capable of recording event information including ECG, audio data (optional), and SHOCK/NO-SHOCK recommendations.

When connected to a patient who is unconscious and not breathing, the *DDU-100* AED performs the following tasks:

- Prompts the operator to take necessary actions to enable analysis.
- Automatically analyzes the patient’s ECG.
- Determines whether a shockable rhythm is present.
- Charges the defibrillation capacitor and arms the SHOCK button if the AED detects a shockable rhythm.
- Prompts the operator to press the SHOCK button when the device is ready and a shock is recommended.
- Delivers a shock once the device has determined a shock is required and the SHOCK button has been pressed.
- Repeats the process if additional shocks are required.

The Defibtech *DDU-100* AED will **NOT** shock a patient automatically; it will only advise the operator. The SHOCK button is enabled only when a shockable rhythm is detected and the device is charged and ready to shock. Charging occurs automatically when the device detects a shockable rhythm. The operator must press the SHOCK button to initiate defibrillation.

The *DDU-100* AED uses two self-adhesive defibrillation/monitoring pads to monitor ECG signals and, if necessary, to deliver defibrillation energy to the patient. These pads (also known as electrodes) are provided in a single-use, disposable package.

The *DDU-100* AED determines proper pad-to-patient contact by monitoring the impedance between the two pads (impedance varies with the electrical resistance of the patient’s body). Visual and audio prompts inform the operator of possible problems with patient contact. Voice prompts and visual

indicators communicate the status of the AED and of the patient to the operator. The *DDU-100* AED has two push-button controls and several LED indicators.

Defibrillation energy is delivered as an impedance compensated biphasic truncated exponential waveform. The device delivers 150 Joules into a 50-ohm load when using adult pads or when using attenuated child / infant pads, 50J of defibrillation energy into a 50-ohm load. Energy delivered does not change significantly with patient impedance, although the duration of the generated waveform will vary. The Defibtech AED is designed to deliver up to 150J of defibrillation energy through a patient impedance range of 25 – 180 ohms or 50J of defibrillation energy when using the child / infant pads.

Defibrillation and AED operating power is supplied by a replaceable (non-rechargeable) lithium battery pack that provides for long standby life and low maintenance operation. Battery packs are available in several configurations optimized for use in specific applications. Each pack is marked with an expiration date.

The *DDU-100* AED records event documentation internally and, optionally, on Defibtech Data Cards (“DDC”). The optional DDC plugs into a slot in the AED and enables the AED to record event documentation, and audio (audio enabled cards only) if sufficient space is available on the card. Audio recording is available only for units with installed audio-enabled Defibtech Data Cards. Event documentation stored internally can be downloaded onto a DDC for review.

1.2 The Defibtech DDU-100 AED

- A. **Speaker.** The speaker projects the voice prompts when the *DDU-100* AED is on. The speaker also emits a “beep” when the unit is in standby mode and has detected a condition that requires operator attention.
- B. **SHOCK button.** This button will flash when a shock is recommended - push this button to deliver the shock to the patient. This button is disabled at all other times.
- C. **“analyzing” LED** (Light Emitting Diode). This green LED flashes when the *DDU-100* AED is analyzing the patient’s ECG rhythm.
- D. **“do not touch patient” LED.** This red LED flashes when the *DDU-100* AED detects motion or other interference that prevents analysis of the signal or when the user should not be touching or moving the patient.
- E. **“check pads” LED.** This red LED flashes when the *DDU-100* AED detects that the pad connection to the patient is poor or pads are not applied.
- F. **ON/OFF button.** Push button to turn the *DDU-100* AED on. Push again to disarm and turn the AED off.

- G. Pads connector port.** Insert Patient Pads Connector (item O) into this port to connect pads to *DDU-100* AED.
- H. Battery pack.** The battery pack provides a replaceable main power source for the *DDU-100* AED.
- I. Battery pack opening.** Insert the battery pack firmly into this opening until the latch clicks into place.
- J. Battery pack eject button.** This button releases the battery pack from the *DDU-100* AED. To remove the battery pack, push the button until the battery pack is partially ejected from the unit.
- K. Active Status Indicator (ASI).** When the unit is off, this indicator blinks green to indicate the unit is fully operational and blinks red to indicate unit needs attention from the user or servicing.
- L. Patient pads.** The defibrillation/monitoring pads that are placed on the patient. The pads may be stored in the pad storage area on the back of the unit.
- M. Defibtech Data Card (DDC).** This optional plug-in card provides enhanced storage capabilities to the *DDU-100* AED.
- N. Active Status Indicator (ASI) battery.** This is a 9V lithium battery that provides power to the Active Status Indicator. It is inserted into a compartment in the battery pack.
- O. Patient pads connector.** Insert into Pads Connector Port (item G) to connect pads to the *DDU-100* AED.

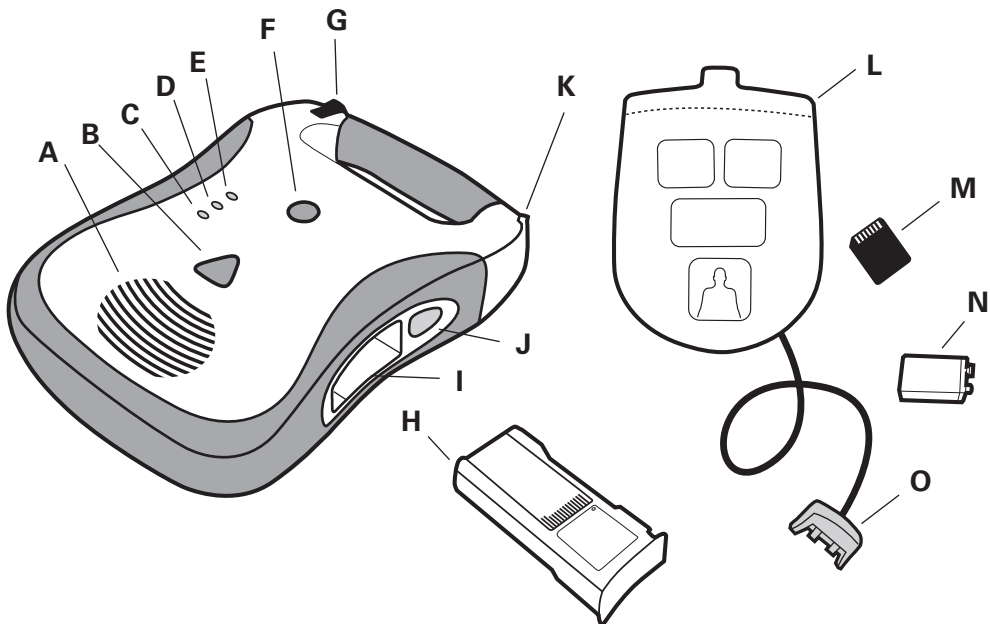

1.3 Indications

The *DDU-100* AED is indicated for use on victims of sudden cardiac arrest (“SCA”) when the patient is:

- Unconscious and unresponsive.
- Not breathing.

For patients under 8 years old, use child/infant electrode pads. Do not delay therapy to determine exact age or weight.

The *DDU-100* AED must be used by or on the order of a physician.

1.4 Contraindications

The *DDU-100* AED should not be used if the patient shows any of the following signs:

- Conscious and/or responsive.
- Breathing.
- Has a detectable pulse.

1.5 Operator Training Requirements

In order to safely and effectively operate the *DDU-100* AED, a person shall have met the following requirements:

- Defibtech *DDU-100* AED and/or defibrillation training as required by local, state, provincial, or national regulations.
- Any additional training as required by the authorizing physician.
- Thorough knowledge and understanding of the material presented in this User Manual.

2 Dangers, Warnings and Cautions

This chapter includes a list of danger, warning, and caution messages that relate to the Defibtech *DDU-100* AED and its accessories. Many of these messages are repeated elsewhere in this User Manual and on the *DDU-100* AED or accessories. The entire list is presented here for convenience.

- DANGER:** Immediate hazards that will result in serious personal injury or death.
- WARNING:** Conditions, hazards, or unsafe practices that may result in serious personal injury or death.
- CAUTION:** Conditions, hazards, or unsafe practices that may result in minor personal injury, damage to the *DDU-100* AED, or loss of data.

2.1 Shock, Fire Hazard, Explosion

2.1.1 Electricity



Hazardous electrical output. This equipment is for use only by qualified personnel.

2.1.2 Battery Pack



Follow all battery pack labeling instructions. Do not install battery packs after the expiration date.



Lithium battery packs are not rechargeable. Any attempt to recharge a lithium battery pack may result in fire or explosion.



Do not immerse battery pack in water or other liquids. Immersion in fluids may result in fire or explosion.



Do not attempt to recharge, short-circuit, puncture, or deform battery. Do not expose battery to temperatures above 50°C (122°F). Remove battery when depleted.



Recycle or dispose of lithium battery packs in accordance with federal, state, and/or local laws. To avoid fire and explosion hazard, do not burn or incinerate the battery.

2.1.3 Usage Environment



Possible explosion hazard if used in the presence of flammable anesthetics or concentrated oxygen.



The *DDU-100* AED has not been evaluated or approved for use in hazardous locations as defined in the National Electric Code standard. In compliance with IEC classification the *DDU-100* AED is not to be used in the presence of flammable substance/air mixtures.



Do not immerse any portion of this product in water or other fluids. Do not allow fluids to enter the device. Avoid spilling any fluids on this device or accessories. Spilling fluids into the *DDU-100* AED may damage it or present a fire or shock hazard. Do not autoclave or gas sterilize the *DDU-100* AED or its accessories.



The *DDU-100* AED should be stored and used only within the range of environmental conditions specified in the technical specifications.

2.1.4 Defibrillation/Shock Delivery



Defibrillation current can cause operator or bystander injury. Do not touch the patient during defibrillation. Do not touch equipment connected to the patient or metal objects in contact with the patient during defibrillation. Disconnect other electrical equipment from the patient before defibrillating. Disconnect the *DDU-100* AED from the patient prior to use of other defibrillators.



Improper use can cause injury. Use the *DDU-100* AED only as instructed in the User Manual. The *DDU-100* AED delivers electrical energy that can potentially cause death or injury if it is used or discharged improperly. Do not discharge with defibrillation pads touching or gel surface exposed.



Disconnect all non-defibrillator proof equipment from the patient before defibrillation to prevent electrical shock hazard and potential damage to that equipment.



Avoid contact between parts of the patient's body and conductive fluids such as water, gel, blood or saline, and metal objects, which may provide unwanted pathways for defibrillating current.

2.1.5 Maintenance



Electrical shock hazard. Dangerous high voltages and currents are present. Do not open unit, remove covers, or attempt repair. There are no user serviceable components in the *DDU-100* AED. Refer servicing to qualified service personnel.

2.2 Improper Device Performance

2.2.1 Usage Environment



Radio frequency (RF) interference from RF devices such as cellular phones and two-way radios can cause improper AED operation. In accordance with IEC 801.3, a distance of 2 meters (6 feet) between RF devices and the *DDU-100* AED is recommended.



Although the *DDU-100* AED is designed for a wide variety of field use conditions, rough handling beyond specifications can result in damage to the unit.

2.2.2 Pads



Use only Defibtech disposable self-adhesive defibrillation/monitoring pads, battery packs, and other accessories supplied by Defibtech or its authorized distributors. Substitution of non-Defibtech approved accessories may cause the device to perform improperly.



Follow all defibrillation pad label instructions. Use defibrillation pads prior to their expiration date. Do not re-use defibrillation pads. Discard defibrillation pads after use (in the event of suspected pad malfunction, return pads to Defibtech for testing).



The defibrillation pads are intended for one time use only and must be discarded after use. Reuse can lead to potential cross infection, improper performance of the device, inadequate delivery of therapy and/or injury to the patient or operator.

2.2.3 Patient Analysis



Aggressive or prolonged CPR to a patient with defibrillation pads attached can cause damage to the pads. Replace the defibrillation pads if they become damaged during use.



CPR during analysis can cause incorrect or delayed diagnosis by the patient analysis system.



Do not place adult defibrillation pads in the anterior-posterior (front-back) position. A shock or no shock decision may be inappropriately advised. The *DDU-100* AED requires that the adult defibrillation pads be placed in the anterior-anterior (front-front) position.



Some very low amplitude or low frequency rhythms may not be interpreted as shockable VF rhythms. Also some VT rhythms may not be interpreted as shockable rhythms.



Handling or transporting the patient during ECG analysis can cause incorrect or delayed diagnosis, especially if very low amplitude or low frequency rhythms are present. During analysis and from "Shock Advised" until "Shock Delivered," patient movement and vibration must be minimized.



In patients with cardiac pacemakers, the *DDU-100* AED may have reduced sensitivity and not detect all shockable rhythms. If you know the patient has an implanted pacemaker, do not place electrodes directly over an implanted device.

2.2.4 Shock Delivery



Do not allow defibrillation pads to touch each other, or to touch other ECG electrodes, lead wires, dressings, transdermal patches, etc. Such contact can cause electrical arcing and patient skin burns during defibrillation and may divert defibrillating energy away from the heart.



During defibrillation, air pockets between the skin and defibrillation pads can cause patient skin burns. To help prevent air pockets, make sure self-adhesive defibrillation pads completely adhere to the skin. Do not use dried out or expired defibrillation pads.

2.2.5 Maintenance



Periodic user-initiated and automatic self-tests are designed to assess the *DDU-100* AED's readiness for use. However, no degree of testing can assure performance or detect abuse, damage, or a defect that occurred after the most recent test is completed.



Use of damaged equipment or accessories may cause the device to perform improperly and/or result in injury to the patient or operator.



Improper maintenance can cause the *DDU-100* AED not to function. Maintain the *DDU-100* AED only as described in this User Manual. The AED contains no user serviceable parts – do not take the unit apart.



No modification of this equipment is allowed.

2.3 General



CAUTION



Federal law (USA) restricts this device to sale by or on the order of a physician.

3 Setting up the DDU-100 AED

This chapter describes the steps required to make your Defibtech *DDU-100* AED operational. The *DDU-100* AED is designed to be stored in a “ready” state. This chapter tells you how to make the device ready, so that if and when you need it, few steps are required to begin using the device.

3.1 Overview

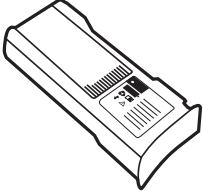
The following components and accessories are included with your *DDU-100* AED. Replacement and other accessories are detailed in the “*DDU-100* AED Accessories” section. Before getting started, identify each component and ensure that your package is complete.

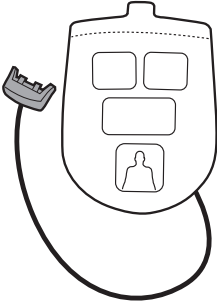
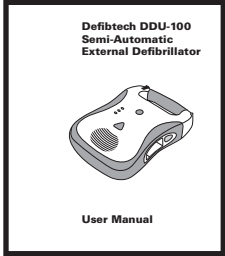
<ul style="list-style-type: none">• <i>DDU-100</i> AED 	<ul style="list-style-type: none">• Battery pack 
<ul style="list-style-type: none">• 9V lithium battery 	<ul style="list-style-type: none">• Defibtech Data Card (DDC) (optional) 
<ul style="list-style-type: none">• Defibrillation pad package 	<ul style="list-style-type: none">• User Manual 

3.2 Installing the Data Card

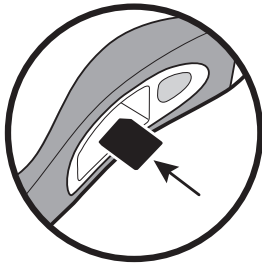

The Defibtech Data Card (“DDC”) is used to store event and audio information collected by the AED. All **DDU-100** AEDs will operate without DDCs and will still store critical event information internally. Different DDC versions store different amounts of information. DDCs are available in versions that store and don’t store audio information. Refer to the DDC technical specification for exact storage capabilities. DDCs may be reviewed with a separate PC based software package - see “Event Viewing” section.

To install the DDC, remove the battery pack and push the DDC, label side up, into the thin slot in the side of the AED centered over the battery pack opening. The card should click into place and be flush with the surface of the slot. If the card does not push in all the way, it may have been inserted upside down. In that case, remove the card, flip it over and try inserting it again.

To remove the DDC, press the card in all the way and then let go. The DDC will be partially ejected and can be removed by pulling it the rest of the way out.

3.3 Installing the Active Status Indicator 9V Battery

A user-replaceable lithium 9V battery, located inside the battery pack, provides Active Status Indicator (“ASI”) power. This auxiliary battery is used to provide standby indicator power independently of the main lithium battery (contained in the battery pack) allowing the main battery pack to have a significantly longer shelf and standby life.

The unit will operate without a 9V battery installed in the battery pack, but active status indication will not be provided. If no 9V battery is installed, status can still be checked by turning the unit on. Only a fresh 9V lithium battery should be used as a replacement. Refer to the Maintenance section for more information on replacement batteries.

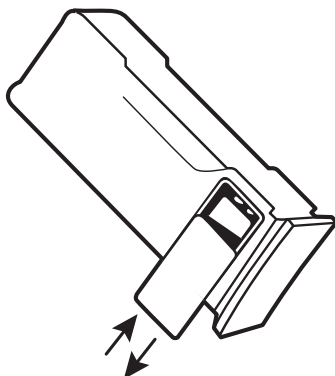

The 9V battery is installed into the battery pack in the 9V battery compartment. To install, remove the cover covering the 9V battery compartment by pushing on it sideways. The cover will slide and detach from the battery pack. Insert the 9V battery into the 9V battery compartment so that the contacts on the battery touch the contacts in the battery pack. The orientation of the battery contacts is shown in a picture on the inside bottom of the 9V battery compartment. Replace the 9V battery compartment door by placing it in the almost closed position and then sliding it closed.

If the battery pack is stored outside the unit for an extended period of time, removal of the 9V battery will extend the 9V battery's life. Note that in an emergency situation, the battery pack may be used without a 9V battery. If needed, a non-lithium based 9V battery may also be used, but standby status indication life will be reduced.

Once the fresh 9V battery is installed, the battery pack status LED should periodically flash green to indicate a ready state. If the indicator does not flash, either the battery pack is defective or the 9V battery is discharged. Once the battery pack is installed into the unit, the *DDU-100* AED's Active Status Indicator should flash green every five seconds.

3.4 Installing and Removing the Battery Pack

The lithium battery pack provides power to the *DDU-100* AED. Before inserting the battery pack into the AED, the 9V lithium battery should be installed in the battery pack itself as described in the previous section.

In an emergency, the battery pack can be used without a 9V battery, but under normal operating conditions the 9V battery should be installed. Do not install the battery pack after the expiration date printed on the label. The battery pack is non-rechargeable.

A green Active Status Indicator on the label side of the battery pack will blink periodically to indicate that the battery pack is ready for use. If the status indicator is not blinking, either the 9V status battery has discharged or the battery pack is not suitable for use. If the indicator does not blink after a new 9V battery has been installed, the battery pack should no longer be used and should be removed from service. When the battery pack is in the AED, a "beep" will provide notice that the 9V battery's capacity is low and that the 9V battery should be replaced.

To insert the battery pack into the *DDU-100* AED, orient the battery pack so that the label faces up. Make certain that the battery opening in the side of the AED is clean and clear of any foreign objects. Insert the battery pack into the opening in the side of the AED. Slide the pack all the way in until the latch clicks. If the pack does not slide all the way in, it is most likely inserted upside down. Once fully inserted, the battery pack surface should be flush with the side of the AED.

To remove the battery pack, push the battery eject button on the side of the AED. After the battery pack is partially ejected, pull the battery pack out.

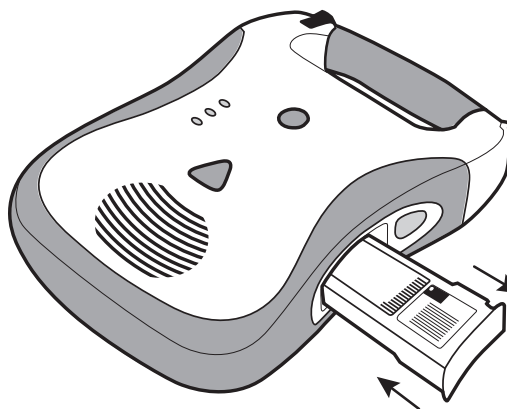

Within moments of insertion (if a non-discharged 9V ASI battery is installed) the DDU-100 will turn on and run a battery pack insertion self-test. The unit will automatically shut off after the test is run. Afterwards, the Active Status Indicator on the top corner of the *DDU-100* AED will periodically flash (if a nondischarged 9V ASI battery was previously installed in the battery pack). If the indicator flashes green, the AED and battery pack are functioning properly, if the indicator flashes red, there is a problem. Refer to the "Checking DDU-100 AED Status" section for more details on the meaning of the indicator.

3.5 Connecting the Pads

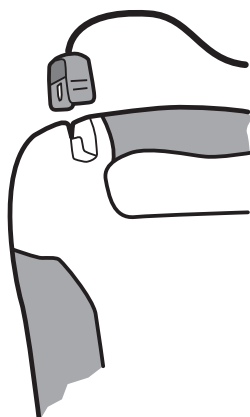

The *DDU-100* AED defibrillation/monitoring pads are supplied sealed in a pouch with the connector and part of the cable exposed. This allows the pads to be stored in a pre-connected state for rapid deployment during an emergency.

Caution: DO NOT remove the defibrillation pads from the sealed package until the pads are to be used. The packaging should be opened only immediately prior to use, otherwise the pads may dry out and become non-functional.

Note: The *DDU-100* AED is designed to be stored with the pads connector already installed. This simplifies the procedure for setting up and operating the device in an emergency.

First, check to ensure that the pad package has not expired. Pads past their expiration date should not be used and should be discarded.

Insert the connector end of the defibrillation pad cable into the pads connector port on the top-left corner of the *DDU-100* AED as shown. Insert pads connector firmly until it is fully seated in the unit.

The connected pad package can then be stored in the pad storage slot in the back of the *DDU-100* AED. After connecting the pads connector to the unit, push the pad package, with the pictures on the package facing out, rounded end first, into the pad holder compartment on the back of the AED. When the pad package is fully inserted, press the pad cable into the groove in the back of the unit to hold it in place and tuck any excess cable behind the pad package.

Caution: The pads are intended for one time use only and must be discarded after use or if the package has been opened.

3.6 Performing Manually Initiated Self-Tests

Upon initial setup, perform a manually initiated Self-Test as described in the following paragraph.

To perform a manual Self-Test, begin with the unit powered off. Press **and hold** the ON/OFF button until the unit announces that it is performing a Self-Test – this should take approximately 5 seconds. Once you hear the announcement, release the ON/OFF button. The unit will then prompt you to “press flashing shock button.” When prompted, press and release the flashing SHOCK button. The unit will run a series of internal tests, including charge and shock tests. The manually initiated Self-Test can be aborted by pressing the ON/OFF button again to turn the unit off. When the Self-Test is complete, the unit will announce its status and power off.

If the Self-Test passes: The unit will announce “UNIT OK” and power off. The unit may then be immediately used by pressing the ON/OFF button again.

If the Self-Test fails: The unit will announce the symptom. The user should refer to the “Troubleshooting” section in Chapter 5 of this manual for appropriate action.

Note: Every time the manually initiated Self-Test is run, the unit does an internal shock test. This test reduces the capacity of the battery pack by one shock.

In addition, every time a battery pack with a non-depleted 9V battery is inserted, the unit runs a Battery Pack Insertion Self-Test to test the battery pack. When the test is completed, the unit reports the status of the battery pack and powers off. The unit may then be immediately used by pressing the ON/OFF button again.

3.7 Storing the DDU-100 AED

The *DDU-100* AED (preferably with pads attached) should be stored in environmental conditions within range of the specifications - refer to the “Environmental” section of “Technical Specifications.” The unit should also be stored so that the Active Status Indicator can be readily seen.

The Active Status Indicator should periodically blink with a green light. If it blinks with a red light or does not blink at all, the *DDU-100* AED needs servicing – refer to the “Checking Active Status Indicator” section for more information.

Defibtech recommends storing your AED in an easily accessible location.

4 Using the DDU-100 AED

This chapter describes how to use the *DDU-100* AED. The *DDU-100* AED was designed for simple operation, allowing the operator to focus on the patient. There are only two control buttons and four light emitting diode (LED) indicators. Concise and easily understandable voice messages and prompts guide the operator through the use of the unit.

The following sections describe in detail how to use the *DDU-100* AED. The basic steps for use are:

- Turn the *DDU-100* AED ON by pressing the ON/OFF button.
- Connect pads to AED if not yet connected.
- Place pads on patient (follow instructions on pad package).
- Follow voice prompts.
- Press SHOCK button if instructed by the AED.

4.1 Overview

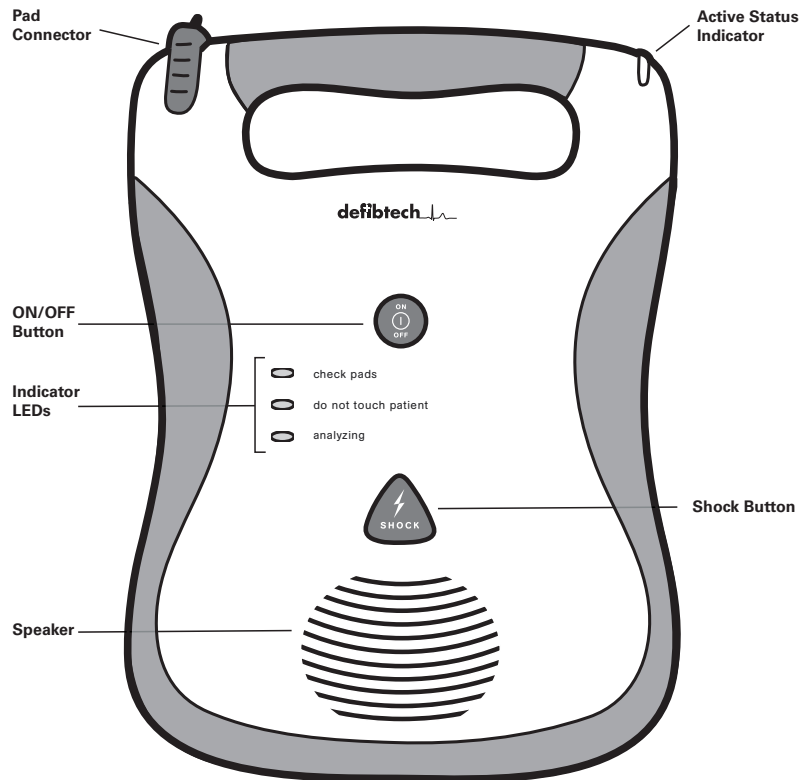

4.2 Checking DDU-100 AED Status

Once a fully functional battery pack with a non-discharged 9V battery is installed in the *DDU-100* AED, an LED indicator located in the corner of the unit actively indicates unit status. If the unit is fully operational, the Active Status Indicator (“ASI”) will blink green and if the unit needs attention, the ASI will blink red. Anytime the ASI blinks red and a good 9V battery is installed, the unit will also “beep” periodically to call attention to itself.

The indicator is powered by a replaceable 9V battery in the battery pack. If the 9V battery has discharged, active status indication will not be available. In this case, the 9V battery should be immediately replaced to restore active status indication. If only the 9V battery is depleted, the *DDU-100* AED will still be fully functional when turned on and can be used in the on-state normally.

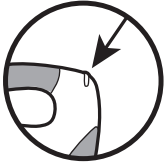
	<p>Active Status Indicator</p>	<ul style="list-style-type: none">• Off: Battery pack not installed, AED is defective, or the 9V battery is discharged. Install functional battery pack or replace the 9V battery in the battery pack.• Steady-On green: <i>DDU-100</i> AED is ON and operating normally.• Blinking green: <i>DDU-100</i> AED is OFF and ready to operate normally.• Blinking red: <i>DDU-100</i> AED is OFF and the AED or battery pack needs attention.• Steady-On red: <i>DDU-100</i> AED is ON and has detected an error.
---	---------------------------------------	---

4.3 Turning on the DDU-100 AED

Press the ON/OFF button to turn the *DDU-100* AED on. The unit will emit a “beep” and all the LEDs will light up temporarily. The ON/OFF button will illuminate green anytime the AED is on. Voice prompts will guide the operator in the use of the unit. To turn the unit off, press the button again. The Active Status Indicator (“ASI”) will indicate the state of the unit.

	<p>ON-OFF/ DISARM</p>	<ul style="list-style-type: none">• ASI off or blinking: The device is OFF. Press green ON/OFF button to turn the device ON.• ASI on (green): The device is ON. Press green ON/OFF button to turn device OFF.• ASI on (red): An error has been detected and unit will turn off automatically.
---	------------------------------	---

4.4 Preparation

4.4.1 Call for Help

As soon as the AED is turned on the unit will prompt the user to “call for help.” This indicates that the first step in a rescue should always be to contact professional emergency services.

If another person is available, the user should direct that person to call for help and then continue the rescue without delay.

4.4.2 Preparing the Patient

Prepare the patient by removing any clothing from the patient’s chest. Wipe away moisture from the chest if necessary (the defibrillation pads will stick better on dry skin). If necessary, shave excessive chest hair, which can prevent effective patient-electrode contact. To ensure that electrode pads fully contact the patient’s skin, check that no jewelry or other objects are directly underneath where the pads will be placed.

4.4.3 Opening the Pad Package

Remove the pad package from the pad storage slot at the back of the AED. Open the pad package by tearing along the dotted line, starting at the black arrow (follow directions on the package). Pull the protective backing from the pads and check that the pads are:

- Free from obvious signs of damage.
- Clean of excessive debris (for example, dirt if the pad was dropped).
- Not dried out, and that the gel is sticky and will adhere to the patient.
- Not expired. Do not use pads after the expiration date printed on the package.

If any of these conditions is found, use a new set of pads.

4.4.4 Connecting Defibrillation Pads to the DDU-100 AED

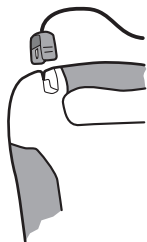

The *DDU-100* AED is designed to be stored with the defibrillation pad connector attached to the unit, while the pads themselves remain sealed in their package. This reduces the time needed to setup and start treatment in an emergency. The Defibtech AED should be stored with the pad connector plugged into the unit. However, if pads were damaged or not properly connected, you may need to substitute a new set of pads during an emergency. The pad connector is on the corner of the AED.

To remove an old set of pads, pull firmly on the pad connector. Do not reuse used pads. Insert the connector for the new pads as shown. The connector will only fit in one way – if the connector does not fit, rotate the connector before trying again. Insert connector firmly until it is completely seated in the unit.

If not needed for immediate use, the pad package can then be stored in the pad storage slot in the back of the **DDU-100** AED. After connecting the pads connector to the unit, push the pad package, with the pictures on the package facing up and out, rounded end first, into the pad holder compartment on the back of the AED. When the pad pack is fully inserted, press the pad cable into the groove in the back of the unit to hold it in place and tuck any excess cable behind the pad package.

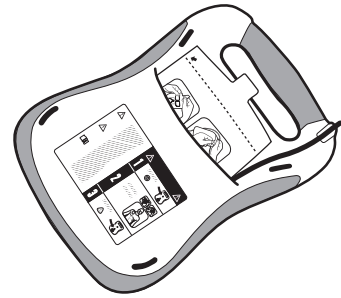

4.4.5 Applying Pads to the Patient

Correct pad placement is essential for effective analysis of the patient's cardiac rhythm and subsequent shock delivery (if required). Remove the pads from the pad package by tearing the package along the dotted line near the top of the package. Remove the pads from the package and follow the directions and diagram showing proper defibrillation pad placement located on the defibrillation pad package. Peel off the protective backing from each pad before placing it as shown on the picture on the pad. Peel the backing off only when the pad is ready to be placed. Place the pads with the sticky side of the pad on the patient's skin. Pad placement on infants or children under 8 years is different than placement for adults or children 8 years or older. Place the pads as shown in the diagram.

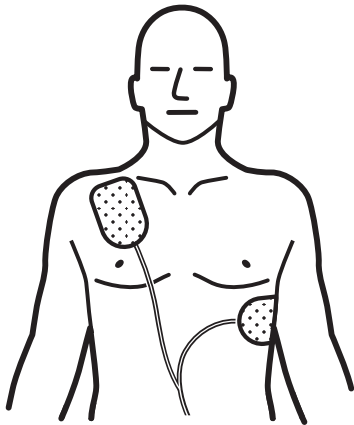

For adults and children 8 years or older use adult pads: Place one pad just below the patient's right collar bone as shown in the picture. Place the second pad over the ribs on the patient's left side below the left breast, also as shown.

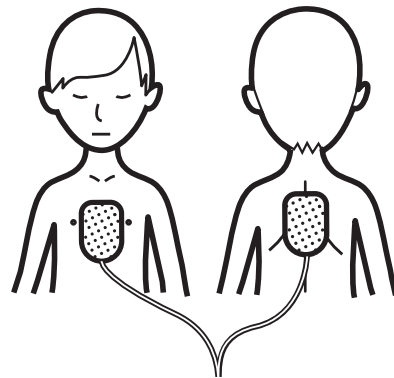

For infants and children under 8 use child/infant pads: Place one pad in the center of chest and back, as shown.

4.4.6 Follow DDU-100 AED Prompts

At this point, the *DDU-100* AED will check to make sure that the pads are well connected to the patient and that an adequate ECG signal is being received. Do not touch the patient, eliminate any patient movement, and cease CPR at this time.

If there is a problem with the pad connection, connector connection, patient motion or other interference, the AED will guide the operator with audible and visual prompts. Visual prompts consisting of flashing LEDs with associated labeling reinforce the audio prompts and aid in high ambient noise environments.

Pad related voice prompts:

“Plug in pads connector” – This indicates that the *DDU-100* AED has determined that the pads are not properly connected to the unit. Check that the connector is fully inserted into the unit. If the prompts continue, try removing and reinserting the pads connector or try a new set of pads. The “check pads” LED will flash red during this message.

“Remove pads from package in back of unit” – This indicates that the user should remove and tear open the pad package located in the back of the unit.

“Apply pads to patient’s bare chest as shown” – This indicates that the *DDU-100* AED has determined that the pads are not placed on the patient. Place pads on the patient following instructions on the pad package. If the prompts continue, try replacing the pads with a new set. The “check pads” LED will flash red during this message.

“Plug in and apply pads” – This indicates that the *DDU-100* AED has determined that the pads are not plugged in and not applied to the patient. Check that the connector is fully inserted into the unit. If the prompts continue, try removing and reinserting the pads connector or try a new set of pads. The “check pads” LED will flash red during this message.

“Poor pad contact to patient,” “Press pads firmly” – This indicates that the pads are not making proper contact with the patient and that the impedance is out of range for proper ECG analysis and shock delivery. Check that the pads are properly placed and fully adhering to the patient and that there are no air bubbles between the pads and the patient. Make sure that the pads are not touching each other. If the pads are not sticking due to moisture, dry the patient. If the pads are not sticking due to excessive hair, shave or clip excessive chest hair. If the prompts continue, try replacing the pads with a new set. The “check pads” LED will flash red during this message.

“Replace pads” – This indicates that the pads are not making proper contact with the patient and that the impedance is out of range for proper ECG analysis and shock delivery. If another set of pads is available, replace the pads, otherwise check that the pads are properly placed and fully adhering to the patient. Make sure that the pads are not touching each other. If the pads are not sticking due to moisture, dry the patient. If the pads are not sticking due to excessive hair, shave or clip excessive chest hair. If the prompts continue, try replacing the pads with a new set. The “check pads” LED will flash red during this message.

“Check pads” – This indicates that the pads are making improper contact with the patient or touching each other and that the impedance is out of range for proper ECG analysis and shock delivery. Check that the pads are not touching each other and that the patient is dry. If the prompts continue, try replacing the pads with a new set. The “check pads” LED will flash red during this message.

“Pausing for CPR” – This indicates that the user should stop attempting to resolve problems with the pads and assess the condition of the patient. The user will be prompted to begin CPR, if needed, for a two-minute period.

Motion/Interference related voice prompts:

“Stop motion” – This indicates that the *DDU-100* AED has detected motion in the patient. Stop all patient motion, including CPR, in response to this message. If the patient is being transported, stop the vehicle to stop the motion. The “do not touch patient” LED will flash red during this message.

“Stop interference” – This indicates that the *DDU-100* AED has detected interference on the ECG signal. Eliminate any radio or electrical sources of interference. Check the pads to make sure they are adhering properly to the patient. If the environment is very dry, minimize movement around the patient to reduce static discharges. The “do not touch patient” LED will flash red during this message.

“Pausing for CPR” – This indicates that the user should stop attempting to resolve motion and/or interference problems and assess the condition of the patient. The user will be prompted to begin CPR, if needed, for a two-minute period.

4.5 Heart Rhythm Analysis

Once the *DDU-100* AED has determined that the pads are making a good connection to the patient, the AED will start the ECG rhythm analysis. The unit analyzes the ECG signal and determines whether a shockable or non-shockable rhythm is present. While analyzing, the AED will continue to monitor the pad connections and will abort analysis if it detects any pad problems. It will also continue to monitor for excessive motion or interference and will abort analysis if those conditions are detected.

Analysis related voice prompts:

“Analyzing heart rhythm” – This indicates that the DDU-100 AED is actively analyzing the patient’s ECG signal. The AED will continue analyzing until it has determined whether a rhythm is shockable or non-shockable or analyzing is interrupted for some reason. The “analyzing” LED will flash green during this period.

“Do not touch the patient” – This indicates that the DDU-100 AED is trying to analyze the patient’s heart rhythm and that the operator should not touch the patient. This message will be spoken at the beginning of the analysis period and also if motion or interference has been detected. The “do not touch patient” LED will flash red during this message.

“Analyzing interrupted” – This indicates that the DDU-100 AED has determined that accurate ECG analysis is not possible and has ceased analyzing. The operator is prompted to resolve the problem – see “Follow DDU-100 AED Prompts” section. Once the problem is resolved, the unit will enter analysis mode again. The “analyzing” LED will not be illuminated during this message.

“No shock advised” – This indicates that the DDU-100 AED has determined that a shock is not required. The unit will not charge and the SHOCK button will not be enabled. The user will be prompted to begin CPR, if needed, for a period of two minutes.

“Shock advised” – This indicates that the DDU-100 AED has determined that a shock is recommended and the unit will begin charging in anticipation of a defibrillation shock. Analysis will continue and the “analyzing” LED will continue to flash green.

4.6 Delivering the Shock

If the *DDU-100* AED ECG analysis algorithm has determined that a shock is required, the unit will automatically charge in preparation for shock delivery. While the AED charges, the unit will continue to analyze the patient’s heart rhythm. If the unit detects that the heart rhythm has changed to one that does not require a shock, the unit will abort the charging process and will prompt the user to begin CPR, if needed, for a period of two minutes. Also while charging, the AED will continue to monitor the pad connections and will abort charging if it detects any pad problems. It will also continue to monitor for excessive motion or interference and will abort charging if those conditions are detected. The user can abort at any time by pushing the ON/OFF button to turn the unit off.

Shock related voice prompts:

“Charging” – This indicates that the *DDU-100* AED has determined that a shock is recommended and is charging the unit in anticipation of a defibrillation shock. Analysis will continue during this phase and the “analyzing” LED will continue to flash green. A tone will sound to indicate charging progress. If the unit detects a rhythm change to a non-shockable one, charging will abort and the user will be prompted to begin CPR, if needed, for a period of two minutes.

“Stand clear” – This indicates that the *DDU-100* AED is charging and that the operator and others should stand clear of the patient. Analysis will continue during this phase and the “analyzing” LED will continue to flash green. A tone will sound to indicate charging progress. If the unit detects a rhythm change to a non-shockable one, charging will abort and the user will be prompted to begin CPR, if needed, for a period of two minutes.

“Press flashing shock button” – This indicates that the *DDU-100* AED has fully charged, that the heart rhythm analysis algorithm still indicates a shock is recommended, and the unit is ready to deliver a shock. The operator should press the SHOCK button to deliver the shock. The “Shock” button will flash during this phase.

	SHOCK	<ul style="list-style-type: none">• Off: No Shock indicated. Button is disabled, pressing the button will do nothing.• Flashing: Shock is recommended. The device is charged and ready to shock. Button is enabled. Press the button to administer shock.
---	--------------	--

“Shock ‘x’ delivered” – This indicates that the *DDU-100* AED has delivered the shock. The ‘x’ indicates the number of shocks that have been delivered since the unit was turned on (note: if the unit delivers more than 15 shocks during one on period, the count will get reset to “one” on the sixteenth shock). After each shock, the AED will enter Post-Shock CPR mode (see below).

“Shock cancelled” – This indicates that the *DDU-100* AED has aborted shock mode and internally discharged. If while waiting for the shock button to be pressed, the unit detects a rhythm change to a non-shockable rhythm, the unit will cancel the shock. Also, if the shock button is not pressed within 30 seconds of the initial “press flashing shock button” prompt, the unit will automatically cancel the shock.

Note: The *DDU-100* AED will not automatically deliver a shock – the user must press the SHOCK button.

Note: At any time during the charging process or after the AED has been charged, the operator may disarm the unit by pressing the ON/OFF button.

4.7 No Shock Required

If the DDU-100 AED ECG analysis algorithm has determined that a shock is not required, it will not charge the unit and the SHOCK button will not be enabled. The operator will be prompted to begin CPR, if needed, for a period of two minutes. The unit will not be monitoring the patient's ECG rhythm during this two minute CPR period.

During this two-minute period, the AED will not advise the user to "stop motion" even if motion is present. During the two-minute period, the AED will announce time remaining in 15-second intervals. At the end of the two-minute period, the unit will enter normal Analyzing mode.

No Shock Required Voice Prompts:

"It is safe to touch the patient" – This indicates that the *DDU-100* AED analysis algorithm has determined that no shock is required. The unit will not charge and the SHOCK button will not be enabled. The user will be prompted to begin CPR, if needed, for a period of two minutes. The "analyzing" LED will remain off to indicate that background rhythm monitoring has been suspended.

"Check airway", "Check breathing" – This indicates that the user should check the condition of the patient in order to determine if it is appropriate to perform CPR.

"If needed, begin CPR" – This indicates that the user should begin CPR, if needed, for two minutes. The unit will not be monitoring the patient's ECG rhythm during this two minute CPR period. The "analyzing" LED will remain off to indicate that background rhythm monitoring has been suspended.

"Continue for 'x' seconds" or "Continue for 1 minute 'x' seconds" – This indicates that the user should continue CPR, if needed, for 'x' more seconds or, for 1 minute and 'x' more seconds, respectively. The unit will not be monitoring the patient's ECG rhythm during this two minute CPR period. The "analyzing" LED will remain off to indicate that background rhythm monitoring has been suspended.

"Continue" – This indicates that the user should continue CPR, if needed. This phrase is spoken between the "continue for 'x' seconds" or "continue for 1 minute 'x' seconds" prompts to let the operator know that the unit is still operating normally. The unit will not be monitoring the patient's ECG rhythm during this two minute CPR period. The "analyzing" LED will remain off to indicate that background rhythm monitoring has been suspended.

"Continue for 5, 4, 3, 2, 1", "Stop CPR" – This indicates that the user should finish performing CPR. This phrase is spoken during the last several seconds of the two-minute CPR period to let the operator know that the unit is still operating normally and that the two-minute period is ending.

“Stop now”, “Do not touch the patient” – This indicates that the two-minute CPR period has ended and the user should stop CPR. The unit will enter Analyzing mode and the “analyzing” LED will flash.

4.8 Post-Shock CPR

If the DDU-100 AED has delivered a shock, the unit will require a mandatory two-minute CPR period. No patient ECG rhythm monitoring will be done during this period. Once the two-minute period is complete, the AED will continue in Analyzing mode.

Post-Shock CPR Voice Prompts:

“It is safe to touch the patient” – This indicates that it is safe for the user to touch the patient. The unit will not be monitoring the patient’s ECG rhythm during this required two minute CPR period. The “do not touch patient” LED will be off to indicate that it is safe to touch the patient.

“Begin CPR now” – This indicates that the user should perform CPR for two minutes. The unit will not be monitoring the patient’s ECG rhythm during this required two-minute CPR period. The “analyzing” LED will remain off to indicate that background rhythm monitoring has been suspended.

“Continue for ‘x’ seconds” or **“Continue for 1 minute ‘x’ seconds”** – This indicates that the user should continue performing CPR for ‘x’ more seconds or, for 1 minute and ‘x’ more seconds, respectively. The unit will not be monitoring the patient’s ECG rhythm during this required two-minute CPR period. The “analyzing” LED will remain off to indicate that background rhythm monitoring has been suspended.

“Continue” – This indicates that the user should continue performing CPR. This phrase is spoken between the “continue for ‘x’ seconds” or “continue for 1 minute ‘x’ seconds” prompts to let the user know that the unit is still operating normally. The unit will not be monitoring the patient’s ECG rhythm during this required two-minute CPR period. The “analyzing” LED will remain off to indicate that background rhythm monitoring has been suspended.

“Continue for 5, 4, 3, 2, 1; “Stop CPR” – This indicates that the user should finish performing CPR. This phrase is spoken during the last several seconds of the required two-minute CPR period to let the user know that the unit is still operating normally and the two-minute period is ending.

“Stop now”, “Do not touch the patient” – This indicates that the mandatory two-minute CPR period has ended and the user should stop CPR. The unit will enter Analyzing mode and the “analyzing” LED will flash.

4.9 Post Use Procedures

After the *DDU-100* AED has been used on a patient, the unit should be cleaned following procedures in the “Cleaning” section and prepared for the next use. The following steps should be performed:

- Remove battery pack.
- Remove DDC if installed. Replace with a new DDC.
- Reinsert battery pack. Check that the Battery Pack Insertion Self-Test passes.
- Connect a new pad package (check to make sure the package is not expired).
- Hold ON/OFF button down for at least five seconds to initiate a manually initiated Self-Test. Unit will report status of the Self-Test and shut off.
- Check to make sure that the Active Status Indicator is flashing green.

4.10 Operational Environment

The Defibtech AED is designed to operate in a wide range of environmental conditions. To ensure the reliability and safety of the AED in a given environment, refer to the “Environmental” section for a detailed list of approved environmental conditions.

5 Maintaining and Troubleshooting the DDU-100 AED

This chapter describes the maintenance and troubleshooting procedures for the *DDU-100* AED. The Self-Tests that are performed by the device are described along with the frequency and nature of periodic maintenance for which the owner/operator is responsible. A troubleshooting guide is provided to help diagnose user serviceable problems.

The *DDU-100* AED contains no user serviceable parts except for the ASI 9V battery.

5.1 Self-Tests

Power-On Self-Tests are performed every time the unit is turned on to test the basic operation of the unit. The unit also performs daily, weekly, monthly and quarterly self-tests automatically when a non-depleted 9V battery is present to check the integrity of the unit's hardware and software.

Manually initiated Self-Tests may be run to test the *DDU-100*'s systems, including the charging and shocking functions (the shock is internally dissipated and no voltage will be present at the pads) at any time.

Note: Every time the manually initiated Self-Test is run, the unit does an internal shock test. This test reduces the capacity of the battery pack by one shock.

To perform a manual Self-Test, begin with the unit powered off. Press and hold the ON/OFF button until the unit announces that it is performing a Self-Test – this should take approximately 5 seconds. Once you hear the announcement, release the ON/OFF button. The unit will prompt you to “press flashing shock button.” When prompted, press and release the flashing SHOCK button. The unit will run a series of internal tests, including charge and shock tests. The manually initiated Self-Test can be aborted by pressing the ON/OFF button again to turn the unit off. When the Self-Test is complete, the unit will announce its status and power off.

If the Self-Test passes: The unit will announce: “UNIT OK” and power off. The unit may then be immediately used by pressing the ON/OFF button again.

If the Self-Test fails: The unit will announce the symptom. The user should refer to the “Troubleshooting” section in Chapter 5 of this manual for appropriate action.

5.2 Routine Maintenance

Although the *DDU-100* AED is designed to be very low maintenance, simple maintenance tasks must be performed by the owner/operator on a regular basis to ensure the unit's dependability.

Daily	Monthly	After Each Use	Action
●	●	●	Check that Active Status Indicator is flashing green
	●	●	Check the condition of the unit and accessories
		●	Run manually initiated Self-Test
		●	Replace pads
	●		Check pads and battery pack expiration dates
		●	Check the DDC if one was installed

5.2.1 Checking Active Status Indicator

The Active Status Indicator ("ASI") is located in the upper corner of the *DDU-100* AED and indicates the operational readiness state of the unit. It will periodically flash green to indicate a fully functional condition. If it is flashing red or not flashing at all, the AED needs attention. Anytime the ASI is flashing red and a good 9V battery is installed, the unit will periodically emit a "beep" to call attention to itself.

If the ASI is not flashing at all, the most likely cause is that the ASI 9V battery needs to be replaced. Follow the directions in the "Replacing the Lithium 9V ASI Battery" section to replace the ASI battery. Once the battery has been replaced with a fresh battery, the ASI should once again flash green. If it does not, the battery pack may be defective. In that event, the battery pack should be replaced. If it still does not flash after inserting a new battery pack, the *DDU-100* AED is non-operational and needs servicing.

If the ASI is flashing red, turn the *DDU-100* AED on. If the unit does not turn on or does not speak, the AED is non-operational and requires servicing. If the unit does turn on, the voice prompts will indicate the nature of the problem.

Maintenance Related Voice Prompts:

“Power-on self-test failed, service code ‘xxx’ ” – This indicates that the *DDU-100* AED has failed the power-on self-test and is non-operational and needs servicing. The code number will indicate to the service personnel the type of problem that the unit is experiencing.

“Battery pack self-test failed, service code ‘xxx’ ” – This indicates that the *DDU-100* AED’s battery pack is non-operational and needs servicing. The code number will indicate to the service personnel the type of problem that the unit is experiencing.

“Service required” – This indicates that the unit has detected an error which rendered it inoperable, and the unit requires servicing.

“Battery pack low” – This indicates that the battery pack capacity is low and should be replaced soon. The AED will still be able to deliver at least a minimum of three defibrillation shocks the first time this message is spoken.

“Replace battery pack” – This indicates that the battery pack is almost discharged and that the AED may not be able to deliver defibrillation shocks. The battery pack should be replaced immediately.

“Replace 9 volt battery” – This indicates that the 9V battery in the battery pack needs to be replaced. The unit may not provide active status indication during standby mode in this condition, but the AED is still fully functional when turned on and may be used to treat patients. The 9V battery should be replaced as soon as possible.

“Pads missing” – This indicates that pads were not found connected during a self test.

5.2.2 Checking the Condition of the Unit and Accessories

Inspect the device for dirt and contamination, especially in the connector socket and around the battery pack opening. Refer to the “Cleaning” section for guidance on cleaning your AED.

Inspect the device visually for damage. Look for cracks or other signs of damage on the case, especially near the connector socket and joints.

If any cracks or other signs of damage are visible, remove the AED from service and contact an authorized service center.

5.2.3 Running a Manually Initiated Self-Test

The *DDU-100* AED runs a Power-On Self-Test every time the unit is powered up to test the basic operation of the unit. The unit also runs daily, weekly and monthly automatic Self-Tests when a non-depleted 9V battery is present.

Note: Every time the manually initiated Self-Test is run, the unit does an internal shock test. This test reduces the capacity of the battery pack by one shock.

To perform a manual Self-Test, begin with the unit powered off. Press and hold the ON/OFF button until the unit announces that it is performing a Self-Test – this should take approximately 5 seconds. Once you hear the announcement, release the ON/OFF button. The unit will prompt you to “press flashing shock button.” When prompted, press and release the flashing SHOCK button. The unit will run a series of internal tests, including charge and shock tests. The manually initiated Self-Test can be aborted by pressing the ON/OFF button again to turn the unit off. When the Self-Test is done, the unit will announce its status and power off.

If the Self-Test passes: The unit will announce “UNIT OK” .The unit may then be immediately used by pressing the ON/OFF button again.

If the Self-Test fails: The user should refer to the “Troubleshooting” section in Chapter 5 of this manual.

5.2.4 Replacing Pads

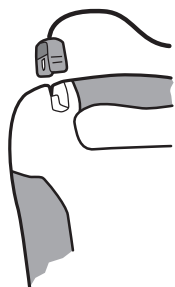

The Defibtech defibrillation/monitoring pads are intended for one time use only. The pads must be replaced after each use or if the package has been damaged.

The *DDU-100* AED defibrillation/monitoring pads are supplied in a sealed pouch with the connector and part of the cable exposed. The *DDU-100* AED is designed to be stored with the electrode cable already installed. This allows the pads to be stored in a pre-connected state for rapid deployment during an emergency.

Caution: DO NOT remove the defibrillation pads from the sealed package until the pads are to be used. The packaging should be opened only immediately prior to use, otherwise the pads may dry out and become non-functional.

First, check to ensure that the pad package has not expired. Pads past their expiration date should not be used and should be discarded. Next, check to ensure that the pads package has not been torn, opened or damaged. Dispose of the pads if the package is open or damaged. Inspect the pads cable and replace if any nicks, cuts, or broken cables are found. Insert the connector end of the defibrillation pad cable into the pads connector port on the corner of the AED as shown. Press the pads connector in firmly until it is fully seated in the unit.

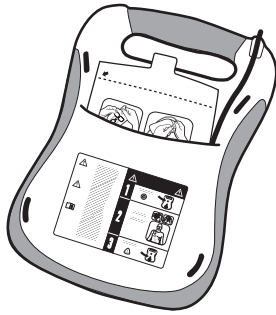

The pad package can then be stored in the pad storage slot in the back of the *DDU-100* AED. After connecting the pads connector to the unit, push the pad package, with the pictures on the package facing up and out, rounded end first, into the pad holder compartment on the back of the AED. When the pad pack is fully inserted, press the pad cable into the groove in the back of the unit to hold it in place and tuck any excess cable behind the pad package.

Caution: The pads are intended for one time use only and must be discarded after use or if the package has been opened.

5.2.5 Checking Pad and Battery Pack Expiration Dates

It is important that the patient pads and the battery packs not be used past their expiration dates. The expiration date of the pad package is printed on the outside of the sealed package. The expiration date of the battery pack is printed on the label on the pack. The battery pack should be removed and replaced by this date; when the battery pack is used up, the unit will indicate “low battery” or “replace battery” and will flash the Active Status Indicator red.

Once an accessory is past its expiration date, it should be replaced immediately. Follow the instructions in the “Installing and Removing the Battery Pack” and “Connecting the Pads” sections to replace the part with an unexpired part. Patient pads should be discarded. Battery packs should be appropriately recycled.

5.2.6 Checking the DDC If One Was Installed

Each time the *DDU-100* AED is used, an event file is created on the DDC (if installed). If the unit was used to treat a patient, the DDC in the unit should be removed and provided to the patient’s care provider. A new DDC should be installed before the next use.

To remove the DDC, first remove the battery pack by pressing the battery pack eject button on the side of the unit. The DDC card is located in a slot directly above the battery pack opening in the unit. To remove the DDC card, press the DDC in all the way and then release. The DDC will be partially ejected and can be removed by pulling it the rest of the way out. To install a new DDC, insert the DDC, label side up, in the thin slot on the top of the opening for the battery pack. The card should click into place and be flush with the surface of the slot. If the card does not push in all the way, it may have been inserted upside down. In that case, remove the card, flip it over and try inserting it again.

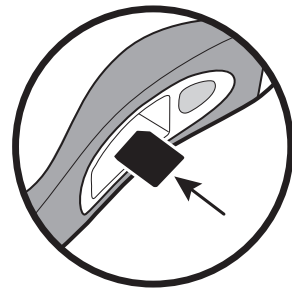

Note: A DDC is not required for the *DDU-100* AED to operate. Even if a DDC card is not installed, basic essential information will still be recorded internally. The AED will still operate properly even after a “replace memory card” message.

5.3 Replacing the Lithium 9V ASI Battery

The 9V ASI battery is located in the battery pack in the 9V battery compartment (see figure). To install, remove the cover covering the 9V battery compartment by pushing on it sideways. The cover will slide approximately a 1/4 inch and then can be detached from the battery pack. Insert the 9V battery into the 9V battery compartment so that the contacts on the battery touch the contacts in the battery pack. The orientation of the battery contacts is shown in a picture on the inside bottom of the 9V battery compartment. Replace the 9V battery compartment door by reversing the process used to remove the door.

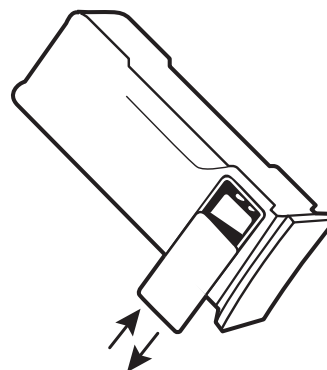

If the battery pack is stored out of the AED for an extended period of time, removal of the 9V battery will extend the 9V battery's life. Note that in an emergency situation, the battery pack may be used without a 9V battery. If needed, a non-lithium based 9V battery may also be used, but standby status indication life will be reduced.

Once the fresh 9V battery is installed, the battery pack status LED should periodically flash green to indicate a ready state. If the indicator does not flash, either the battery pack is defective or the 9V battery is discharged. Once the battery pack is installed into the unit, the *DDU-100* AED's status indicator should periodically flash green.

Note: The unit will operate without a 9V battery installed, but active status indication and automatic self-tests will not be provided. Status can still be checked by turning the unit on.

5.4 Cleaning

Periodically clean the *DDU-100* AED of any dirt or contaminants on the case and connector socket. The following are important guidelines to be adhered to when cleaning the device:

- The battery pack should be installed when cleaning the *DDU-100*.
- Do not immerse the *DDU-100* in fluids or allow fluids to enter the unit. Use a soft cloth to wipe the case clean.
- Do not use abrasive materials or strong solvents such as acetone or acetone based cleaning agents. The following cleaning agents are recommended for cleaning the *DDU-100* case and the connector socket:
 - » Soapy water
 - » Ammonia based cleaners
 - » Hydrogen peroxide
 - » Isopropyl alcohol (70 percent solution)
 - » Chlorine bleach (30 ml / liter water)
- Ensure that the connector socket is completely dry before reinstalling the pads cable. After cleaning the device and before returning it to service, always turn the unit on for a few seconds, which will cause the unit to run a standard Power-On Self-Test.

5.5 Storage

The *DDU-100* AED should be placed in a readily accessible location in an orientation where the Active Status Indicator in the upper corner of the unit can be easily seen. In general, the unit should be stored in clean, dry and moderate temperature conditions. Make sure that the environmental conditions of the storage location are within the ranges detailed in the “Environmental” section.

5.6 Operator's Checklist

The following checklist may be used as the basis for an Operator's Checklist. The table should be copied and filled out as recommend by the schedule in the "Routine Maintenance" section. As each item is completed it should be checked off.

Defibtech DDU-100 Operator's Checklist						
Defibtech DDU-100 Serial Number: _____						
Defibtech DDU-100 Location: _____						
Date:						
Check unit and accessories for damage, dirt and contamination. Clean or replace as necessary.						
Check that spare battery pack and pads available .						
Check that battery pack and pads not past expiration dates.						
Check ASI flashing green.						
Comments:						
Inspection by: (initials or signature)						

5.7 Troubleshooting

The following table lists the common causes for problems, the possible cause and the possible corrective actions. Refer to the other sections of the User Manual for detailed explanations on how to implement the corrective actions. If the unit continues to be non-functional, refer the unit for servicing.

Symptom	Possible Cause	Corrective Action
Unit will not turn on	Battery pack not inserted	Insert battery pack
	Battery pack depleted or non-functional	Replace battery pack
	Unit is non-functional	Return unit for service
Unit immediately turns off	Battery pack depleted	Replace battery pack
	Unit is non-functional	Return unit for service
ASI is solid red	Unit detected an error	Run manually initiated Self-Test
ASI blinks red	ASI 9V battery low	Replace ASI 9V battery
	Unit needs servicing	Turn unit on and run manually initiated Self-Test
	Battery pack non-functional	Replace battery pack
	Electrode pads are not pre-connected to unit	Connect electrode pads to unit
ASI does not blink at all	ASI 9V battery depleted	Replace ASI 9V battery
	Battery pack not inserted	Insert battery pack
	Battery pack non-functional	Replace battery pack
	Unit is non-functional	Return unit for service
Power on self-test failed, service code 'xxx'	Unit needs servicing	Record code number and return unit for servicing
Unit self-test failed, service code 'xxx'	Unit needs servicing	Record code number and return unit for servicing
Battery pack self-test failed, service code 'xxx'	Battery pack needs servicing	Record code number and replace with new battery pack
Service required	Unit needs servicing	Return unit for service
"Replace battery pack" voice prompt	Battery pack capacity is critically low	Unit will probably not deliver a shock, replace battery pack immediately
"Battery pack low" voice prompt	Battery pack capacity is getting low	Unit will still deliver shocks, replace battery pack as soon as possible
"Replace 9 volt battery" voice prompt	9V battery low or missing	Unit will still operate to treat patients, replace 9V battery as soon as possible

Symptom	Possible Cause	Corrective Action
“Plug in pads connector” voice prompt	Connector not in properly	Make sure pads connector is oriented correctly and fully inserted
	Pad connector broken	Replace pads
	Unit’s connector broken	Return unit for servicing
“Apply pads to patient’s bare chest as shown” voice prompt	Pads not connected to patient	Place pads on patient
	Pads not making good connection to patient	Check pad connection to patient
	Pads or pad cable damaged	Replace pads
“Poor pad contact to patient” or “Press pads firmly” voice prompt	Dry pads	Replace pads
	Partial pad connection	Check that pads are placed securely on patient
“Check pads” voice prompt	Pads touching	Separate pads and place correctly on patient
“Stop motion” voice prompt	Patient motion has been detected	Stop patient motion
“Stop interference” voice prompt	External interference has been detected	Stop external interference
“Analyzing interrupted” voice prompt	Motion or interference detected	Stop motion or interference
“Shock cancelled” voice prompt	Patient’s ECG rhythm changed	No action necessary
	Shock button not pushed within 30 seconds	Push shock button within 30 seconds
“Shock not delivered” voice prompt	Low battery – insufficient to charge	Replace battery pack
	Hardware failure	Run manually initiated Self-Test, return unit for servicing
	Bad pad to patient connection	Check that pads are placed securely on patient
	Dry pads	Replace pads
“Replace memory card” voice prompt	DDC card is full	Replace DDC card with a card that is not full
	DDC has failed	Replace DDC card
“Pads missing” voice prompt	Pads not connected	Make sure pads connector is oriented correctly and fully inserted into unit
Unit makes periodic “beep” sound	Unit has detected a condition that needs user attention	Turn unit on to run the power-on Self-Test
All indicator LEDs blinking, unit does not operate	Hardware failure	Run manually initiated Self-Test, return unit for servicing

5.8 Repair

The *DDU-100* AED contains no user serviceable parts. If the unit need servicing, return to an authorized service center. Refer to “Contacts” section for contact information.

6 DDU-100 AED Accessories

This chapter describes the components and accessories that can be used with the Defibtech *DDU-100* AED. Information on obtaining replacement components and accessories is included in the “Contacts” section.

6.1 Defibrillation/Monitoring Pads

The *DDU-100* AED is used with Defibtech self-adhesive defibrillation/monitoring pads for adults or with attenuated pediatric pads for infants and children. These pads (also known as “electrodes”) serve two functions:

- Allow the unit to read the patient’s electrocardiograph (ECG) rhythm.
- Deliver defibrillation energy to the patient when needed.

The Defibtech self-adhesive defibrillation/monitoring pad assembly comes in a “leads-out” sealed package that allows the device to be stored with pads connected. When the *DDU-100* AED is used, the operator needs only to remove the pad packaging, tear open the package and turn the device on to administer care. The AED has a storage area in the back of the unit that allows for storage of a single sealed pad package.

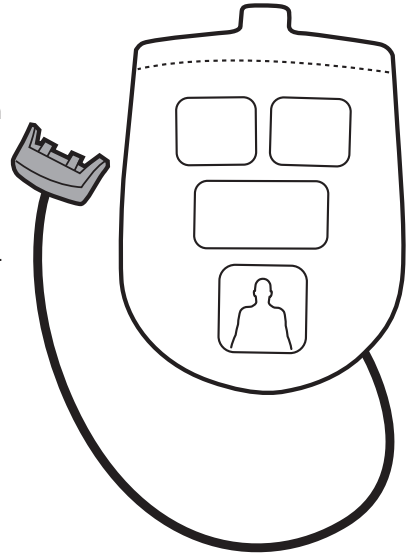

6.2 Battery Packs

The Defibtech AED uses a lithium battery pack. The battery pack contains the main lithium battery cells, an LED status indicator, and a 9V lithium battery. Different capacity battery packs are available. Refer to the “Battery Packs” section for detailed information on the available packs. The battery pack is inserted into the battery pack opening on the side of the AED and latches into place.

The main battery is based on a lithium battery technology and provides the AED with a long shelf and standby life. Battery pack status indication is provided by a blinking green status LED. Status indicator power is supplied by a user replaceable 9V lithium battery.

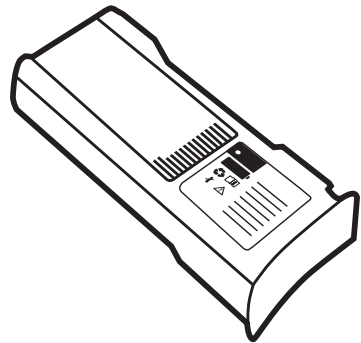

6.2.1 Battery Pack Active Status Indicator

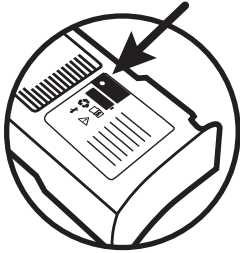

The battery pack's Active Status Indicator ("ASI") is located on the label face of the battery pack and is used to indicate battery pack status. A periodically blinking green LED indicates that the battery pack status is OK and the battery pack is ready for use. Absence of a blinking green LED indicates a battery pack problem or a depleted or missing 9V battery. Refer to the "Checking DDU-100 AED Status" section for information on battery pack LED indications.

6.2.2 Active Status Indicator Battery



The Active Status Indicator ("ASI") battery is a 9V lithium battery. It provides power to the Active Status Indicator to prevent the main defibrillation battery from being depleted for non-essential functions. This provides a significantly longer standby life for the AED and battery pack and extends the lifetime during which the *DDU-100* AED can deliver defibrillation shocks. The Active Status Indicator battery is a lithium 9 volt battery.

6.3 Data Cards

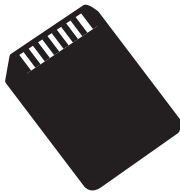

DDU-100 AED is designed to optionally use Defibtech Data Cards ("DDC"). The AED will operate with or without a DDC, but if a DDC is installed, additional event storage capacity is available.

The *DDU-100* AED accepts DDC cards of different capacities, each designed to record an assortment of data for a given period of time. For example, the *DDU-100* AED can record more than ten hours of ECG only or approximately one hour and forty minutes of audio and ECG data on a large DDC card. Cards are available with and without audio logging enabled.

The DDC is inserted into a slot above the battery pack opening in the AED - refer to the “Installing the Data Card” section. A new and initialized DDC card should be used each time the AED is operated to maximize recording time. A new event file is created on the DDC each time the AED is turned on and the following information is recorded (DDC cards may contain a maximum of 255 event files):

- The time the AED was turned on.
- Other data such as: ECG data, time data, audio data (audio enabled card only).
- Event milestones such as: motion detection, shock advice, shock delivery information.

When an audio enabled DDC gets low on available storage, the AED will stop recording the less critical audio data to allow room for additional ECG data in an attempt to record at least one hour of ECG (total recording time is limited by available space on the DDC). Data from a previous event will NOT be erased. If the DDC fills completely, the AED will still be operable and the most critical event documentation for the current session is still recorded internally.

Internally recorded event information can be downloaded for external review by inserting a blank DDC card into the unit. The DDC slot is located just inside the battery pack opening. For instructions on how to install and remove a DDC card, see Section 3.2 (“Installing the Data Card”) of this manual. To download data from the card, refer to Section 7.2 (“Downloading the Internal Data Log”).

6.4 Recycling Information

At the end of its useful life, recycle the defibrillator and its accessories.

6.4.1 Recycling Assistance

For recycling assistance contact your local Defibtech distributor. Recycle in accordance with local and national regulations.

6.4.2 Preparation

Items should be clean and contaminant-free prior to being recycled. When recycling used disposable electrodes, follow local clinical procedures.

6.4.3 Packaging

Packaging should be recycled in accordance with local and national requirements.

6.4.4 Notice to European Union Customers

The crossed-out wheeled bin symbol  on this device indicates that this equipment has been put on the market after 13 August 2005, and is included in the scope of the directive 2002/96/EEC on Waste Electrical and Electronic Equipment (WEEE) and of the national decree(s) which transpose provisions of such directive.

At the end of its lifetime, this device can only be disposed of in compliance with the provisions of the above mentioned European directive (and following possible revisions) as well as with the corresponding national regulation. Severe penalties are possible for unauthorized disposal.

Electrical and Electronic Equipment (EEE) may contain polluting components and hazardous substances the accumulation of which could pose serious risk for the environment and human health. It is for this reason that local Administrations provide regulations which encourage reuse and recycling, and prohibit the disposal of WEEE as unsorted municipal waste and require the collection of such WEEE separately (at specifically authorized treatment facilities). Manufacturer and authorized distributors are required to supply information about a safe treatment and disposition of the specific device.

You may also return this equipment to your distributor when purchasing a new one. As for reuse and recycling, notwithstanding the limits imposed by the nature and the use of this device, the manufacturer will do his best to develop recovery processes. Please contact the local distributor for information.

7 Event Viewing

DefibView is a Windows based software application that reads data stored on a DDC and displays it on a personal computer. DefibView serves four primary functions:

- Enables emergency care personnel to reconstruct a cardiac episode from the time the AED was turned on and connected to the patient until the unit is turned off.
- Enables a patient's primary care giver to review the emergency episode.
- Allows Defibtech and regulatory personnel to reconstruct a cardiac episode for review of device performance.
- Provides maintenance personnel with additional parameter information to assist in troubleshooting a device suspected of malfunctioning.

DefibView is a stand-alone software application. It cannot be used with the AED in operation and exists solely to support post-event review of the data recorded on a DDC or downloaded to a DDC from internal storage. The DDC from an event should be transported to a medical facility with the patient, allowing medical professionals to review the data.

For details about the features and use of the application, refer to the DefibView documentation.

7.1 Defibtech Data Cards

If a DDC is installed in the unit, every time the *DDU-100* is turned on the following information is recorded on a new file on the card:

- The time the AED was turned on.
- Other data such as: ECG data, time data, audio data (audio enabled cards only).
- Event milestones such as: motion detection, shock advice, shock delivery information.

This information can be reviewed using the DefibView application.

7.2 Downloading the Internal Data Log

Regardless of whether a DDC is installed in the unit, select information is recorded internally within the *DDU-100* AED. The information recorded is limited to:

- The time the AED was turned on.
- Other data such as event milestones (motion detection, shock advice, shock delivery information, etc).
- Eight seconds of ECG data immediately before a shock/no-shock decision, eight seconds immediately after each shock, and all ECG data during the charging and waiting-to-shock periods.
- Note: Audio data is not logged internally.

To download the internally logged information, perform the following procedure:

- Insert a blank DDC into the unit.
- Turn the unit on.
- Once the unit is on, turn it off in data download mode by pushing and holding the ON/OFF button for at least five seconds.
- Allow the unit to write the contents of the internal log to the DDC by waiting for the unit to turn off automatically.

The DDU-100 will write the contents of the internal log onto the DDC. This information can then be reviewed using the DefibView software.

8 Technical Specifications

8.1 Defibtech DDU-100 AED

8.1.1 Physical

Category	Specification
Size	8.5 x 11.8 x 2.7 inches (22 x 30 x 7 cm)
Weight	Approximately 4.2 lbs (1.9 kg) with DBP-1400 Battery pack Approximately 4.4 lbs (2 kg) with DBP-2800 Battery pack

8.1.2 Environmental

Category	Specification	
Operating / Maintenance	Temperature	0 – 50°C (32 – 122°F)
	Humidity	5% – 95% (non-condensing)
Standby / Storage	Temperature	0 – 50°C (32 – 122°F)
	Humidity	5% – 95% (non-condensing)
Altitude	-150 to 4500 meters (-500 to 15,000 feet) per MIL-STD-810F 500.4 Procedure II	
Shock / Drop Abuse Tolerance	MIL-STD-810F 516.5 Procedure IV (1 meter, any edge, corner, or surface, in standby mode)	
Vibration	MIL-STD-810F 514.5 Category 20 RTCA/DO-160D, Section 8.8.2, Cat R, Zone 2, Curve G (Helicopter) RTCA/DO-160D, Section 8, Cat H, Zone 2, Curves B&R (Jet Aircraft)	
Sealing	IEC 60529 class IP54; Dust Protected, Splash Proof, (Battery pack installed)	
ESD	EN 61000-4-2:1998 Severity Level 4 (Open air discharges up to 8 kV or direct contact discharges up to 6 kV)	
EMC (Emission)	EN 60601-1-2:2001+A1:2006, method EN 55011:1998 Group 1 Level B (Not to exceed 30 dB µV from 30 Hz to 230 MHz and not to exceed 37 dB µV from 230 to 1000 MHz)	
EMC (Immunity)	EN 60601-1-2:2001+A1:2006, method EN 61000-4-3:1998 Level 3 (Field strength: 10V/m; carrier frequency range: 26 MHz to 1 GHz; AM modulation, 80 percent index, at 3 frequencies: 1, 5, and 20 Hz)	

8.1.3 Defibrillator

Category		Specification
Waveform		Biphasic Truncated Exponential
Energy		Adult: 150 J nominal delivered into a 50 ohm load Infant /child: 50 J nominal delivered into a 50 ohm load
Charge control		Automatic by Patient Analysis System
Charge time from shock-advised		Typically < 6 seconds with a fresh DBP-2800 battery pack and < 9 seconds with a fresh DBP-1400 battery pack. Charge time may increase at the end of battery life and for temperatures below 10°C.
Charge complete indication		<ul style="list-style-type: none"> • SHOCK button flashing • "Press Shock button" voice prompt
Shock delivery		Shock is delivered by a single SHOCK button
DISARM	Automatic	<ul style="list-style-type: none"> • If Patient Analysis System decides rhythm is no longer shockable, or • Within 30 seconds after Charge complete, if operator has not pressed SHOCK button, or • If defibrillation pads are removed from patient or unplugged from unit.
	Manual	<ul style="list-style-type: none"> • If operator presses the OFF/DISARM button at any time to disarm and turns off the device.

8.1.4 Waveform Specifications

The *DDU-100* AED delivers a 150J Biphasic Truncated Exponential waveform to patients with impedances ranging from 25 to 180 ohms.

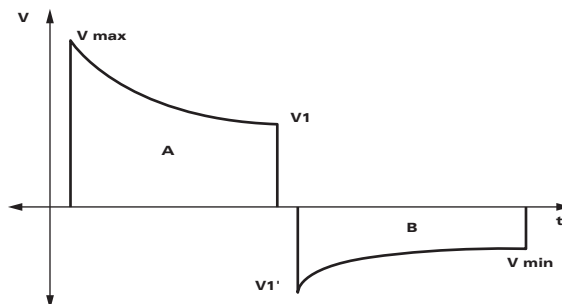

The waveform is adjusted to compensate for measured patient impedance. Nominal phase times and energy delivered are shown in the tables that follow.

Adult

Patient Impedance (Ohms)	Phase A, Duration (msec)	Phase B, Duration (msec)	Energy Delivered (Joules)
25	2.8	2.8	153
50	4.1	4.1	151
75	7.2	4.8	152
100	9.0	6.0	151
125	12.0	8.0	153
150	12.0	8.0	146
175	12.0	8.0	142

Pediatric

Patient Impedance (Ohms)	Phase A, Duration (msec)	Phase B, Duration (msec)	Energy Delivered (Joules)
25	4.1	4.1	35
50	5.8	3.8	47
75	5.8	3.8	51
100	7.2	4.8	53
125	7.2	4.8	52
150	9.0	6.0	53
175	9.0	6.0	51



8.1.5 Patient Analysis System

The Patient Analysis System ensures that the pad/patient impedance is within the proper range and analyzes the patient's ECG rhythm to determine whether a shock is required. On detection of a non-shockable rhythm, the user is prompted to perform CPR. For shockable rhythms, the AED automatically charges in preparation for shock delivery.

The patient analysis system will detect electrical "noise" or artifact in the ECG signal that may interfere with accurate rhythm analysis. This artifact may be caused by excessive motion to the patient or by external electrical noise. When this artifact is present, the AED will prompt the user to "Stop motion" or "Stop Interference" until the ECG signal is free of noise and then proceed to analysis.

8.1.5.1 Shockable Rhythm Criteria

When placed on a patient meeting the indications for use criteria, the *DDU-100* AED is designed to recommend a defibrillation shock when it detects proper pad impedance and one of the following:

Ventricular Fibrillation	Peak-to-peak amplitude at least 200 μ Volts.  Warning: Some very low amplitude or low frequency VF rhythms may not be interpreted as shockable.
Ventricular Tachycardia (including ventricular flutter and polymorphic VT)	Cardiac rhythm rate of at least 180 bpm and peak-to-peak amplitude at least 200 μ Volts.  Warning: Some very low amplitude or low frequency VT rhythms may not be interpreted as shockable.

The *DDU-100* AED is designed to recommend *no* shock for all other rhythms, including Normal Sinus Rhythms, fine Ventricular Fibrillation (<200 μ Volts), and some slow Ventricular Tachycardias and Asystole.

8.1.5.2 Patient Analysis System Performance

Rhythm Class	ECG Test Sample ¹ Size	Algorithm Performance ¹		Specifications
		Performance ²	90% Lower Confidence Limit ²	
Shockable Rhythm – Ventricular Fibrillation	227	>98%	>97%	Meets the AAMI DF39 requirement and AHA recommendation ² of Sensitivity > 90%
Shockable Rhythm – Ventricular Tachycardia	100	99%	>97%	Meets the AAMI DF39 requirement and AHA recommendation ² of Sensitivity > 75%
Non-Shockable Rhythm – Normal Sinus Rhythm	213	100%	100%	Meets the AAMI DF39 requirement of Specificity >95% and the AHA recommendation ² of Specificity > 99%
Non-Shockable Rhythm – Asystole	113	100%	100%	Meets the AAMI DF39 requirement and the AHA recommendation ² of Specificity > 95%
Non-Shockable Rhythm – All other non-shockable rhythms	248	>99%	>98%	Meets the AAMI DF39 requirement and the AHA recommendation ² of Specificity > 95%

1. From Defibtech ECG Rhythm Databases.
2. *Automatic External Defibrillators for Public Access Defibrillation: Recommendations for Specifying and Reporting Arrhythmia Analysis Algorithm Performance, Incorporating New Waveforms, and Enhancing Safety*. American Heart Association (AHA) Task Force on Automatic External Defibrillation, Subcommittee on AED Safety and Efficacy. *Circulation*, 1997;95:1677-1682.

Note: Additional information available upon request.

8.1.6 Clinical Summary

The *DDU-100* AED uses a Biphasic Truncated Exponential waveform with specifications that are substantially equivalent to the waveform specifications of the device used in the study* cited below. The *DDU-100* AED has not been the subject of a published clinical study.

8.1.6.1 Background

The objective of this study was to compare AEDs that delivered 150-J biphasic shocks with AEDs that delivered high-energy (200- to 360-J) monophasic shocks.

* Schneider T, Martens PR, Paschen H, et al. Multicenter, randomized, controlled trial of 150J biphasic shocks compared with 200- to 360-J monophasic shocks in the resuscitation of out-of-hospital cardiac arrest victims. *Circulation* 2000;102:1780-1787.

8.1.6.2 Methods

AEDs were prospectively randomized according to defibrillation waveform on a daily basis in four emergency medical services systems. First responders used either the 150-J biphasic AEDs or 200- to 360-J monophasic waveform AEDs on victims where defibrillation was indicated. A sequence of up to three defibrillation shocks was delivered: 150J-150J-150J for the biphasic units and 200J-200J-360J for the monophasic units. Defibrillation was defined as termination of VF for > 5 seconds, without regard to hemodynamic factors.

8.1.6.3 Results

Of 338 patients with an out-of-hospital cardiac arrest, 115 had a cardiac etiology, presented with ventricular fibrillation, and were shocked with one of the randomized AEDs. There were no statistical differences between the monophasic and biphasic groups in terms of age, sex, weight, primary structural heart diseases, cause or location of arrest, bystanders who witnessed the arrest, or type of responder. A summary of the results is presented in table below.

	Biphasic Patients Number (%)	Monophasic Patients Number (%)	P Value
Defibrillation Efficacy:			
1 shock	52/54 (96%)	36/61 (59%)	< 0.0001
< 2 shocks	52/54 (96%)	39/61 (64%)	< 0.0001
< 3 shocks	53/54 (98%)	42/61 (69%)	< 0.0001
Patients defibrillated	54/54 (100%)	49/58 (84%)	0.003
ROSC	41/54 (76%)	33/61 (54%)	0.01
Survival to Hospital Admission	33/54 (61%)	31/61 (51%)	0.27
Survival to Hospital Discharge	15/54 (28%)	19/61 (31%)	0.69

8.1.6.4 Conclusion

More patients were defibrillated with an initial biphasic shock than monophasic shock and ultimately the biphasic waveform defibrillated at higher rates than the monophasic waveform. A higher percentage of patients achieved Return Of Spontaneous Circulation ("ROSC") after biphasic shocks. Rates of survival to hospital admission and discharge did not statistically differ between the two waveforms.

8.1.7 Guidance and Manufacturer's Declaration – Electromagnetic Emissions and Immunity

Electromagnetic conformity

Guidance and manufacturer's declaration - The DDU-100 is intended for use in the electromagnetic environment specified below. The customer or the user of the DDU-100 should assure that it is used in such an environment.

Electromagnetic emissions

Emissions test	Compliance	Electromagnetic environment – guidance
RF emissions CISPR 11	Group 1 Class B	The DDU-100 uses RF energy only for its internal function. Therefore, its RF emissions are very low and are not likely to cause any interference in nearby electronic equipment. The DDU-100 is suitable for use in all establishments, including domestic establishments and those directly connected to the public low-voltage power supply network that supplies buildings used for domestic purposes.
Harmonic emissions IEC 61000-3-2	Not applicable	
Voltage fluctuations/flicker emissions IEC 61000-3-3	Not applicable	

Electromagnetic immunity

Immunity test	IEC 60601 test level	Compliance level	Electromagnetic environment - guidance
Electrostatic discharge (ESD) IEC 61000-4-2	±6 kV contact ±8 kV air	±6 kV contact ±8 kV air	The DDU-100 uses interference detected and motion detected indicators to notify the user if conditions are not ideal. No other ESD requirements are necessary.
Electrical fast transient/burst IEC 61000-4-4	±2 kV for power line supply lines ±1 kV for input/output lines	Not applicable	
Surge IEC 61000-4-5	±1 kV line(s) to line(s) ±2 kV line(s) to earth	Not applicable	

Immunity test	IEC 60601 test level	Compliance level	Electromagnetic environment - guidance
Voltage dips, short interruptions and voltage variations on power supply input lines IEC 61000-4-11	Not applicable	Not applicable	
Power frequency (50/60 Hz) magnetic field IEC 61000-4-8	3 A/m	3 A/m	Power frequency magnetic fields should not be greater than levels characteristic of a typical location in a commercial or hospital environment.
Radiated RF IEC 61000-4-3	10 V/m 80 MHz to 2.5 GHz	10 V/m	<p>Portable and mobile RF communications equipment should be used no closer to any part of the DDU-100, including cables, than necessary. The recommended separation distance calculated from the equation applicable to the frequency of the transmitter is shown in the following table.</p> <p>Interference may occur in the vicinity of equipment marked with the following symbol:</p> 
<p>Note 1: At 80 MHz and 800 MHz, the higher frequency range applies. Note 2: These guidelines may not apply in all situations. Electromagnetic propagation is affected by absorption and reflection from structures, objects and people.</p>			
<p>The ISM (industrial, scientific and medical) bands between 150 kHz and 80 MHz are 6,765 MHz to 6,795 MHz; 13,553 MHz to 13,567; 26,957 MHz to 27,283 MHz; and 40,66 MHz to 40,70 MHz. Field strengths from fixed transmitters, such as base stations for radio (cellular/cordless) telephones and land mobile radios, amateur radio, AM and FM radio broadcast and TV broadcast cannot be predicted theoretically with accuracy. To assess the electromagnetic environment due to fixed RF transmitters, an electromagnetic site survey should be considered. If the measured field strength in the location in which the DDU-100 is used exceeds the applicable RF compliance level above, the DDU-100 should be observed to verify normal operation. If abnormal performance is observed additional measures may be necessary, such as reorienting or relocating the DDU-100.</p>			

Separation Distances

The DDU-100 is intended for use in an electromagnetic environment in which radiated RF disturbances are controlled. The customer or the user of the DDU-100 can help prevent electromagnetic interference by maintaining a minimum distance between portable and mobile RF communications equipment (transmitters) and the DDU-100 as recommended below, according to the maximum output of the communications equipment.

Recommended separation distances between portable and mobile RF communications equipment and the DDU-100				
Separation distance according to frequency of transmitter (m)				
Rated maximum output power of transmitter (W)	150 kHz to 80 MHz outside ISM bands	150 kHz to 80 MHz inside ISM bands	80 MHz to 800 MHz	800 MHz to 2.5 GHz
	$d = 1.16\sqrt{P}$	$d = 1.2\sqrt{P}$	$d = 1.2\sqrt{P}$	$d = 2.3\sqrt{P}$
0.01	0.01	0.12	0.12	0.23
0.1	0.1	0.37	0.38	0.73
1	1	1.17	1.20	2.30
10	10	3.69	3.79	7.27
100	100	11.67	12.00	23.00

For transmitters rated at a maximum output power not listed above, the recommended separation distance d in meters (m) can be determined using the equation applicable to the frequency of the transmitter, where P is the maximum output power rating of the transmitter in watts (W) according to the transmitter manufacturer.

Note 1: As 80 MHz and 800 MHz, the separation distance for the higher frequency range applies.

Note 2: The ISM (industrial, scientific and medical) bands between 150 kHz and 80 MHz are 6,765 MHz to 6,795 MHz; 13,553 MHz to 13,567; 26,957 MHz to 27,283 MHz; and 40,66 MHz to 40,70 MHz.

Note 3: An additional factor of 10/3 is used in calculating the recommended separation distance for transmitters in the ISM frequency bands between 150 kHz and 80 MHz and in the frequency range 80 MHz to 2.5 GHz to decrease the likelihood that mobile/portable communications equipment could cause interference if it is inadvertently brought into patient areas.

Note 4: These guidelines may not apply in all situations. Electromagnetic propagation is affected by absorption and reflection from structures, objects and people.

8.2 Battery Packs

8.2.1 High-Capacity Lithium Battery Pack

Category	Specification
Model number	DBP-2800
Main battery type	15VDC, 2800 mAh, Lithium/Manganese Dioxide. Disposable, recyclable, non-rechargeable.
Capacity	300 shocks or 16 hours of continuous operation.*
Charge time	< 6 seconds*
Standby-life (installed in unit)	7 years*
Active Status Indicator (ASI) battery	9VDC, 1200 mAh, Lithium/Manganese Dioxide. Disposable, recyclable, non-rechargeable.
ASI battery standby-life (after installation)	>1 year*

*typical, new battery, at 25°C

8.2.2 Standard Lithium Battery Pack

Category	Specification
Model number	DBP-1400
Main battery type	15VDC, 1400 mAh, Lithium/Manganese Dioxide. Disposable, recyclable, non-rechargeable.
Capacity	125 shocks or 8 hours of continuous operation.*
Charge Time	< 9 seconds*
Standby-life (installed in unit)	5 years*
Active Status Indicator (ASI) battery	9VDC, 1200 mAh, Lithium/Manganese Dioxide. Disposable, recyclable, non-rechargeable.
ASI battery standby-life (after installation)	>1 year*

*typical, new battery, at 25°C

8.3 Self-Adhesive Defibrillation/Monitoring Pads

Use only Defibtech Pads with your *DDU-100* AED. Defibtech self-adhesive defibrillation/monitoring pads have the following characteristics:

Category	Specification	
Model number	DDP-100	DDP-200P
Type	Adult	Child < 8 years
Intended use	Disposable	Disposable
Adhesion	Self-adhesive	Self-adhesive
Active gel surface area	103 cm ² each (nominal)	50 cm ² each (nominal)
Cable/connector type	Integrated	Integrated
Cable length	122 cm (typical)	122 cm (typical)

Note: In the event of a suspected pad defect, the pads should be clearly marked “Not for Use” and returned to Defibtech, L.L.C. for analysis. Refer to “Contacts” section for information on defect returns.

8.4 Defibtech Data Cards (DDCs)

Use only Defibtech Data Cards in the *DDU-100* AED. Defibtech Data Cards are available as follows:

Standard DDCs:

Model Number	Details
DDC-6	Up to 6 hours of ECG data
DDC-12	Up to 12 hours of ECG data

Audio enabled DDCs:

Model Number	Details
DDC-50AE	Up to 50 minutes of Audio and 1 hour of ECG data
DDC-100AE	Up to 1 hour and 40 minutes of Audio and ECG data

Note: The *DDU-100* will attempt to log at least an hour of ECG data if possible. In audio enabled DDCs, audio logging will be turned off if needed to preferentially record ECG information. If a partially filled DDC is used, it is possible that only ECG (i.e. no Audio) will be logged. Every time the unit is turned on, a file is created on the DDC – the DDC card can hold a maximum 255 files. Once a card is completely filled with data or files all DDC logging will stop, but selected internal ECG logging will continue.

8.5 DefibView













DefibView is a PC based application program that allows review of ECG data and other patient and device performance parameters after an emergency event.













DefibView runs on various Windows platforms including Windows 98, Windows 2000, and Windows XP. Minimum system requirements for adequate performance are as follows:





- Pentium II Processor at 300 MHz.
- 32 Mbyte System Memory.
- 100 Mbyte free space on hard disk.

Refer to the DefibView documentation for a complete description of the application. DefibView is available for download at the Defibtech website at www.defibtech.com.

9 Glossary of Symbols

Symbol	Meaning
	High voltage present.
	Caution, consult accompanying documents.
	SHOCK Button – Delivers defibrillation shock to the patient when the device is ready to shock.
	ON/OFF/DISARM Button – - Turns the device ON when it is OFF. - Turns the device OFF when it is ON. - DISARMS the device when it is charged and then turns the device OFF.
	Do not expose to high heat or open flame. Do not incinerate.
	Recyclable.
	Consult operating instructions.
	Refer to instruction manual / booklet.
	Do not damage or crush.
	Follow proper disposal procedures.
	Meets the requirements of the European Medical Device Directive. Note: XXXX represents the identification number of the notified body.
	Temperature limitation.

Symbol	Meaning
	Use by (yyyy-mm).
	Defibrillation proof - Can withstand the effects of an externally applied defibrillation shock. Internally powered with defibrillator-proof BF-type patient applied parts (per EN 60601-1).
	Manufacturer.
	Date of manufacture.
	Do not reuse.
	For USA users only.
	Catalogue number.
	Keep dry.
	Handle with care.
	Transportation and storage requirements. See environmental requirements.
	Authorized European Representative.
	Does not contain latex.
	Lot number.
IP54	Dust protected; Protected against water jets.

Symbol	Meaning
	Classified by TUV Rheinland of NA with respect to electric shock, fire, and mechanical hazard only in accordance with UL 60601-1, CAN/CSA C22.2 No.601.1-M90, IEC 60601-1, and IEC 60601-2-4. Conforms to UL Standard UL 60601-1. Certified to CAN/CSA Standard C22.2 No. 601.1-M90.
	Serial number.
	Lithium Manganese Dioxide Battery.
	Product is not sterile.

10 Contacts



Defibtech, L.L.C.
741 Boston Post Road
Guilford, CT 06437 USA

Tel.: 1-(866) 333-4241 (Toll-free within North America)
1-(203) 453-4507
Fax : 1-(203) 453-6657

Email:
sales@defibtech.com (Sales)
reporting@defibtech.com (Medical Device Reporting)
service@defibtech.com (Service and Repair)

European Authorized Representative:



Emergo Europe
Molenstraat 15
2513 BH The Hague
The Netherlands
Tel.: +31 70 345 8570
Fax: +31 70 346 7299



11 Warranty Information

ORIGINAL END USER'S LIMITED WARRANTY*

COVERAGE

Defibtech, LLC provides a limited warranty that the defibrillator and its associated accessories (e.g., batteries and pads), whether purchased concurrently with the defibrillator as part of a configuration or separately, shall be substantially free from defects in material and workmanship. Defibtech's limited warranty shall only extend to the original end user, where the original end user purchased the items from an authorized Defibtech, LLC retailer. This limited warranty may not be assigned or transferred. The terms of the Limited Warranty in effect as of the date of original purchase shall apply to any warranty claims.

LENGTH OF WARRANTY

The defibrillator's limited warranty is for a period of eight (8) years from the date of purchase. The battery's limited warranty is for a period of four (4) years from the date of purchase, but in no event shall the limited warranty period extend past the date printed on the battery. Single use accessories (e.g., the pads) shall have a limited warranty up to use or for a period up to the expiration date, whichever is earlier. The limited warranty for all other accessories is for a period of one (1) year from the date of purchase, or to the expiration date, whichever is earlier.

LIMITED WARRANTY LIMITATIONS

This limited warranty does not cover damage of any sort resulting from, but not limited to, accidents, improper storage, improper operation, alterations, unauthorized service, tampering, abuse, neglect, fire, flood, war, or acts of God. Additionally, this limited warranty does not cover damage of any sort to the defibrillator or its associated accessories resulting from the use of the defibrillator with unapproved accessories or use of the accessories with unapproved medical devices. The defibrillator and its associated accessories are not warranted to be compatible with any other medical device.

LIMITED WARRANTY VOIDED

The limited warranty is immediately voided if: the defibrillator or its associated accessories are serviced or repaired by any entity, including persons, not authorized by Defibtech, LLC; specified maintenance is not performed; the defibrillator is used with one, or more, unauthorized accessories; the associated accessories are used with an unauthorized defibrillator; or the defibrillator or associated accessories are not used in accordance with Defibtech, LLC approved instructions.

EXCLUSIVE REMEDY

At Defibtech, LLC's sole discretion, Defibtech shall have the option to repair, replace, or provide a credit. In the event of replacement, Defibtech shall have the right at its sole discretion to replace the item with a new, or refurbished, same or similar item. Determination of a similar item shall be at the sole discretion of Defibtech. In the case of replacement,

the replacement at a minimum shall reflect the prorated time remaining for the item based on the remaining limited warranty period. In the case of a credit, the credit shall be the prorated value of the item based on the lower of the original item cost of the same or similar item and the remaining limited warranty period. In no event, shall the limited warranty period of a replacement item extend past the limited warranty period of the item it is replacing.

WARRANTY SERVICE

In order to obtain warranty service, contact the retailer from whom the item was purchased, or Defibtech, LLC customer service. In the event an item must be returned, a Return Material Authorization (RMA) number is required. Items returned without an RMA number will not be accepted. The item shall be shipped at the original end user's expense to a destination specified by the retailer or Defibtech, LLC.

OBLIGATIONS AND WARRANTY LIMITS

THE FOREGOING LIMITED WARRANTY IS IN LIEU OF AND SPECIFICALLY EXCLUDES AND REPLACES, TO THE DEGREE PERMITTED BY APPLICABLE STATE LAW, ALL OTHER EXPRESS OR IMPLIED WARRANTIES, INCLUDING, BUT NOT LIMITED TO, THE IMPLIED WARRANTIES OF MERCHANTABILITY AND FITNESS FOR A PARTICULAR PURPOSE.

NO PERSON (INCLUDING ANY AGENT, DEALER, OR REPRESENTATIVE OF DEFIBTECH, LLC) IS AUTHORIZED TO MAKE ANY REPRESENTATION OR WARRANTY CONCERNING THE DEFIBRILLATOR OR ITS ASSOCIATED ACCESSORIES, EXCEPT TO REFER TO THIS LIMITED WARRANTY.

THE EXCLUSIVE REMEDY WITH RESPECT TO ANY AND ALL LOSSES OR DAMAGES RESULTING FROM ANY CAUSE WHATSOEVER SHALL BE AS SPECIFIED ABOVE. DEFIBTECH, LLC SHALL IN NO EVENT BE LIABLE FOR ANY CONSEQUENTIAL OR INCIDENTAL DAMAGES OF ANY KIND, INCLUDING, BUT NOT LIMITED TO, EXEMPLARY DAMAGES, SPECIAL, PUNITIVE, COMMERCIAL LOSS FROM ANY CAUSE, BUSINESS INTERRUPTION OF ANY NATURE, LOSS OF PROFITS OR PERSONAL INJURY, EVEN IF DEFIBTECH, LLC HAS BEEN ADVISED OF THE POSSIBILITIES OF SUCH DAMAGES, HOWEVER OCCASIONED, WHETHER BY NEGLIGENCE OR OTHERWISE, UNLESS APPLICABLE STATE LAW DOES NOT ALLOW SUCH EXCLUSION OR LIMITATION.

**Applicable to defibrillators and associated accessories having a date of manufacture on or after January 1, 2013. For all others, refer to warranty information in effect at the time of manufacture.*

Patents pending.

This product and its accessories are manufactured and sold under one or more of the following United States patents: D514,951; 6,955,864; D499,183.

This product and its accessories are manufactured and sold under license to at least one or more of the following United States patents: 5,591,213; 5,593,427; 5,601,612; 5,607,454; 5,611,815; 5,617,853; 5,620,470; 5,662,690; 5,735,879; 5,749,904; 5,749,905; 5,776,166; 5,800,460; 5,803,927; 5,836,978; 5,836,993; 5,879,374; 6,016,059; 6,047,212; 6,075,369; 6,438,415; 6,441,582.